



www.dtaigroup.com
The Choice of Professionals



Floor Profiles & Accessories

Carpet / Timber / Vinyl

Catalogue Edition 5

AUSTRALIA

Head Office - VICTORIA

ABN 26 007 291 054

P 1800 505 045

E sales@dta-aus.com.au

P.O. Box 318, Patterson Lakes 3197
6 Ashley Park Drive, Chelsea Heights 3196



NEW SOUTH WALES

P 1800 505 045

E sales@dta-aus.com.au

Unit 1/56-58 Jedda Rd, Prestons 2170

WESTERN AUSTRALIA

P 1800 505 045

E dtawa@dta_australia.com.au

Unit 2/12 Horus Bend, Bibra Lake, 6163

QUEENSLAND

P 1800 505 045

E dtaqld@dta-aus.com.au

7 Hinkler Court, Brendale 4500

SOUTH AUSTRALIA

P 1800 505 045

E sales@dta-aus.com.au

NEW ZEALAND

P 09 525 0321

E sales@dtanz.co.nz

2/27 Cain Rd Penrose, Auckland, 1061

DTA reserve the right to change product specifications without notice. Products may vary from pictures shown.
Colours shown are as close as possible to actual accessory colours.

The Choice of Professionals



The Choice of Professionals

DTA has developed a complete range of professional and DIY carpet, laminate and vinyl floor profiles and accessories. Through consultation with the trade in Australia and internationally DTA are able to offer a range of innovative profiles in suitable materials, that satisfy the most demanding customer applications.

TRANSITION COVER PROFILES 5

Carpet Transition Cover	6
Ripple Cover Profile	6
Senior Cover Strip	7
Junior Cover Strip	7
Commercial Cover Strip	8
Hammer Finish Cover Profile	8
Brush Finish Cover Profile	9
Heavy Duty Cover Strip	9
Seamless Transition Ramps	10
Seamless Transition Cover	10
Multi-Height L-Shape Trim	11
Multi-Height Bases	11
Construction Cover	12
Retro-Fit Transition Profile	13
Aluminium Transition Ramp	14

TIMBER / LAMINATE PROFILES 15

End Cover for Laminated/Floating Floor	16
Edge Cover Transition	17
L-Shape End Cover	17

CARPET PROFILES 18

Nap-Down Domestic Hammered Pinned	19
Nap-Down Commercial Hammered Pinned	19
Nap-Down Commercial Hammered Pinless	20
Formable L-Shape Profiles	20
Aluminium L-Shape Profile	21
Carpet Tile Edge	22
Carpet Tile Diminishing Strip	22
Multi Trim Bases	23
Multi Extension Channel	23



STAIR EDGE PROFILES

24

Stair Nosing Short Riser	25
Stair Nosing Long Riser	25
Stair Nosing Vinyl Short Riser	26
Stair Nosing Vinyl Long Riser	26
Stair Nosing Carpet Short Riser	27
Stair Nosing Carpet Long Riser	27
Rebated Nosing Plate	28
Aluminium Stair Nosing Insert	28
All Weather Stair Nosing	29
All Weather Stair Nosing With Luminance Strip	29
Bullnose Stair Nosing	30
Sawtooth Stair Nosing	30
Stair Nosing Self Adhesive	31
Light Bullnose Stair Nosing Self Adhesive	31
Stair Nosing Profile Hammer Finish	32
Vinyl Landing Edge	32
Illuminated Stair Profile	33
Stair Edge Profile	33
Commercial Aluminium Stair Tread	34
Commercial Aluminium Stair Tread with Illumination	34
Fibreglass Flatbar Stair Nosing	35
Fibreglass Stairnosing	35
Gecko Grip Tape	36

VINYL PROFILES

37

Vinyl Transition Edge	38
2 Part Expansion	38
Diminishing Strip	38
Aluminium Vinyl Ramps	39
Aluminium Vinyl Ramp Expansion	40
2mm Vinyl Transition Aluminium	40

FLOOR ACCESSORIES

41

Stainless Steel Screws	42
Nails for Gripper Strip	42
Carpet Heat Seam Tape	43
Tactile Indicators	43

INDEX



TRANSITION COVER PROFILES

TRANSITION COVER PROFILES

DTA transition cover profiles are designed to provide a smooth transition between two different flooring finishes. For example, carpet to tile or carpet to vinyl.

Carpet Transition Cover

- New modern design
- Protects carpet, laminate, vinyl, timber or tile edges
- Available in three anodised colours Plain, Pewter and Bright Bronze
- Screw and plug fixing
- Supplied in 1m & 1.8m lengths

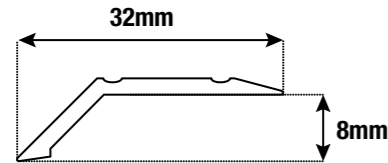

1.0m LONG		8mm HIGH	
Colour	Code	Barcode	Pk Qty
	ACTR1.8PL	9314942666752	20
	ACTR1.8PE	9314942666783	20
	ACTR1.8BR	9314942666813	20

1.8m LONG		8mm HIGH	
Colour	Code	Barcode	Pk Qty
	ACTR18.8PL	9314942666769	20
	ACTR18.8PE	9314942666790	20
	ACTR18.8BR	9314942666820	20

Ripple Cover Profile

- Traditional ripple design
- Protects carpet, laminate, vinyl, timber or tile edges
- Available in three anodised colours Plain, Pewter and Bright Bronze
- Nail fixing
- Supplied in 1m & 1.8m lengths

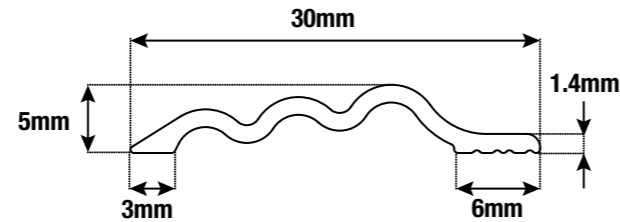

1.0m LONG		5mm HIGH	
Colour	Code	Barcode	Pk Qty
	ACER1.8PL	9314942662372	20
	ACER1.8PE	9314942665939	20
	ACER1.8BR	9314942662389	20

1.8m LONG		5mm HIGH	
Colour	Code	Barcode	Pk Qty
	ACER18.8PL	9314942662396	20
	ACER18.8PE	9314942665946	20
	ACER18.8BR	9314942662402	20

Senior Cover Strip

- Traditional ripple design
- Protects carpet, laminate, vinyl, timber or tile edges
- Available in five anodised colours Mill Finish, Matt Bronze, Matt Champagne, Matt Silver and Pewter
- Nail fixing
- Supplied in 3.3metre lengths

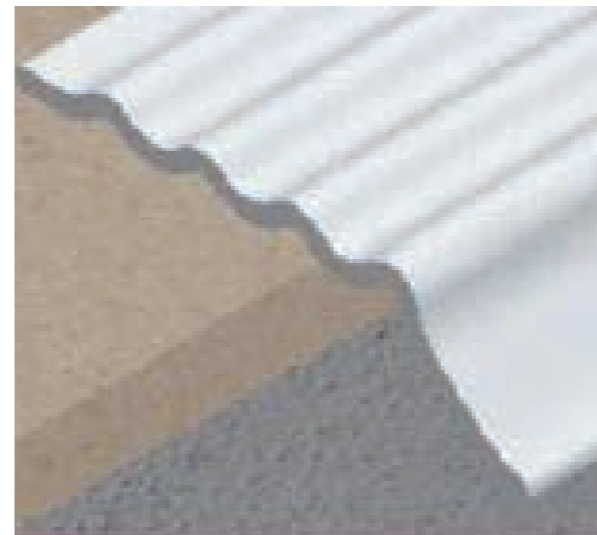
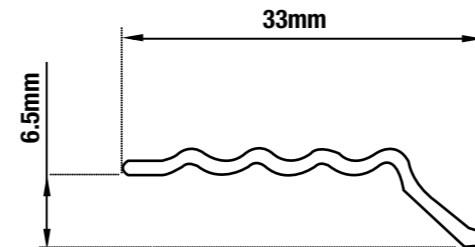
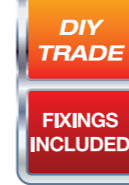

3.3m LONG		6.5mm HIGH	
Colour	Code	Barcode	Pk Qty
	ACER33.12	9314942691877	10
	ACER33.12NMB	9314942691839	10
	ACER33.12NMC	9314942691846	10
	ACER33.12NMS	9314942691860	10
	ACER33.12NPE	9314942691853	10

Junior Cover Strip

- Traditional ripple design
- Protects carpet, laminate, vinyl, timber or tile edges
- Available in five anodised colours Mill Finish, Matt Bronze, Matt Champagne, Matt Silver and Pewter
- Nail fixing
- Supplied in 3.3metre lengths

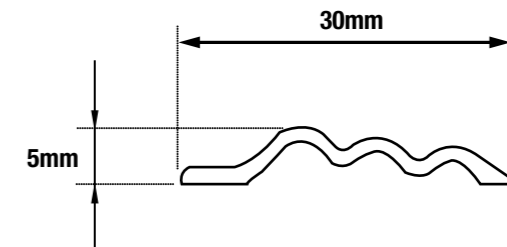

3.3m LONG		5mm HIGH	
Colour	Code	Barcode	Pk Qty
	ACER33.8	9314942691877	10
	ACER33.8NMB	9314942691785	10
	ACER33.8NMC	9314942691792	10
	ACER33.8NMS	9314942691815	10
	ACER33.8NPE	9314942691808	10

Commercial Cover Strip

- Traditional ripple design
- Protects carpet, laminate, vinyl, timber or tile edges
- Available in Mill Finish
- Nail fixing
- Supplied in 3.66m lengths

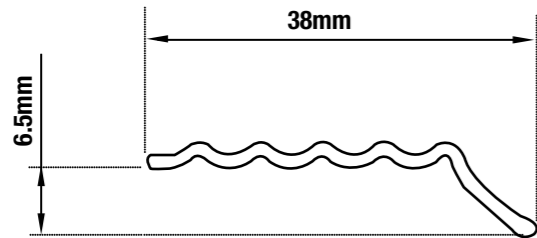

3.66m LONG		6.5mm HIGH		
Colour	Code	Barcode	Pk Qty	
	Mill Finish	ACER33.14	9314942691884	10

Hammer Finish Cover Profile

- Classic hammer finish
- Protects carpet, laminate, vinyl, timber or tile edges
- Available in Plain, Pewter, Bright Bronze, Champagne, Silver and Black
- Nail fixing
- Supplied in 1m, 1.8m and 3.3m lengths

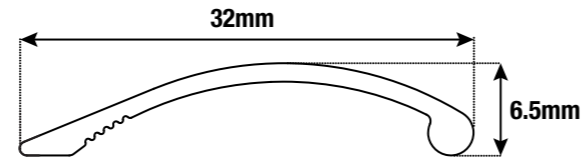

1.0m LONG		6.5mm HIGH		
Colour	Code	Barcode	Pk Qty	
	Plain	ACEC1.8PL	9314942662433	20
	Pewter	ACEC1.8PE	9314942665960	20
	Bright Bronze	ACEC1.8BR	9314942662440	20

1.8m LONG		6.5mm HIGH		
Colour	Code	Barcode	Pk Qty	
	Plain	ACEC18.8PL	9314942662457	20
	Pewter	ACEC18.8PE	9314942665977	20
	Bright Bronze	ACEC18.8BR	9314942662464	20

3.3m LONG		6.5mm HIGH		
Colour	Code	Barcode	Pk Qty	
	Mill Finish	ACEC33.8	9314942691778	20
	Bright Bronze	ACEC33.8NMB	9314942691730	20
	Champagne	ACEC33.8NMC	9314942691747	20
	Silver	ACEC33.8NMS	9314942691761	20
	Pewter	ACEC33.8NPE	9314942691754	20
	Black	ACEC33.8NMBL	9314942692225	20

Brush Finish Cover Profile

- Contemporary brush design
- Protects carpet, laminate, vinyl, timber or tile edges
- Available in Stainless Steel and Bright Bronze
- Nail fixing
- Supplied in 1m and 1.8m

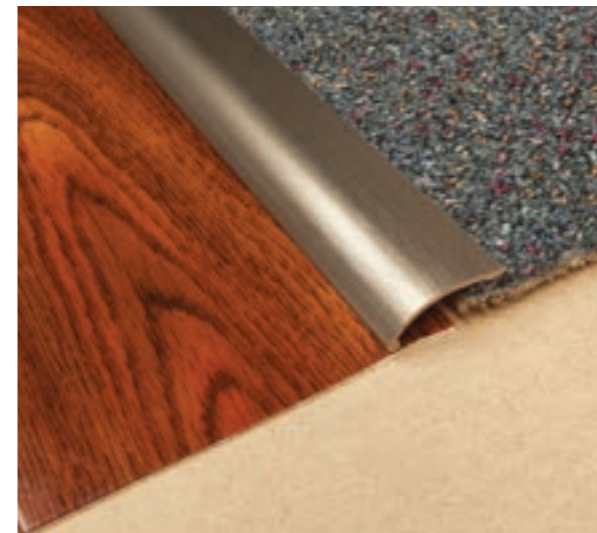
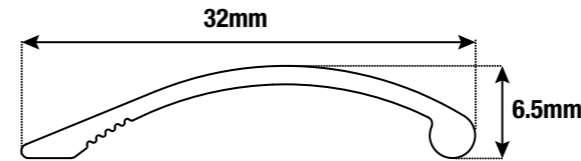

1.0m LONG		6.5mm HIGH		
Colour	Code	Barcode	Pk Qty	
	Stainless Steel	ACECB1.8SS	9314942666677	20
	Bright Bronze	ACECB1.8BR	9314942667094	20

1.8m LONG		6.5mm HIGH		
Colour	Code	Barcode	Pk Qty	
	Stainless Steel	ACECB18.8SS	9314942666684	20
	Bright Bronze	ACECB18.8BR	9314942667100	20

Heavy Duty Cover Strip

- The heavy duty construction makes it ideal for high traffic areas
- Protects carpet, timber, vinyl, laminate or tile edges
- Available in Matt Silver and Matt Black
- Countersunk screw fixing at 200mm intervals
- Supplied in 3.66m lengths

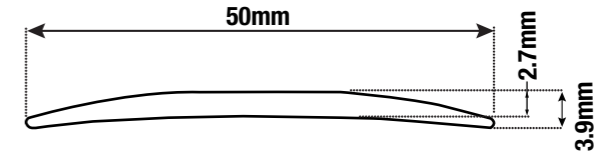

3.66m LONG		3.9mm HIGH		
Colour	Code	Barcode	Pk Qty	
	Matt Silver	ACP36.50NMS	9314942691907	10
	Matt Black	ACP36.50NMBL	9314942691891	10

Seamless Transition Ramps



- Multi-height bases designed for use with seamless transition covers and seamless transition ramps
- Available in Matt Silver, Matt Bronze, Matt Champagne and Matt Black
- Supplied in 3.3m lengths

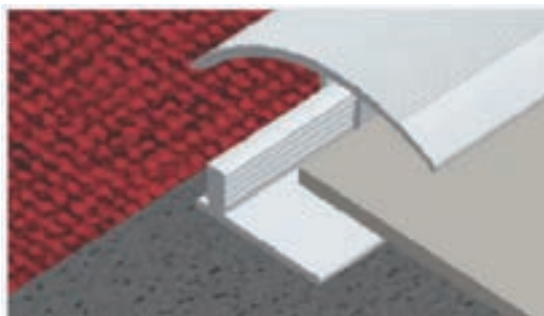
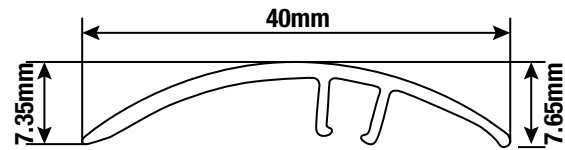

3.3 m LONG		7.65 mm HIGH	
Colour	Code	Barcode	Pk Qty
Matt Silver	MHTR33NMS	9314942692072	10
Matt Bronze	MHTR33NMB	9314942692058	10
Matt Champagne	MHTR33NMC	9314942692065	10
Matt Black	MHTR33NMBL	9314942692041	10

Seamless Transition Strip



- Multi-height bases designed for use with seamless transition covers and seamless transition ramps
- Available in Matt Silver, Matt Bronze, Matt Champagne and Matt Black
- Supplied in 3.3m lengths

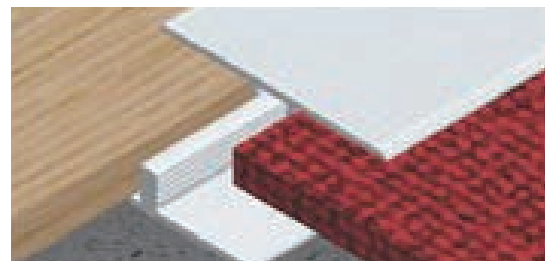
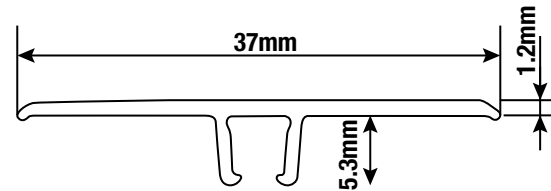

3.3 m LONG		5.3 mm HIGH	
Colour	Code	Barcode	Pk Qty
Matt Silver	MHTC33NMS	9314942692034	10
Matt Bronze	MHTC33NMB	9314942692010	10
Matt Champagne	MHTC33NMC	9314942692027	10
Matt Black	MHTC33NMBL	9314942692003	10

Multi-Height L-Shape Trim



- Designed for use on perimeters of flooring installations
- Available in 4 colours, Matt Silver, Matt Bronze, Matt Champagne and Matt Black
- Use with MHB5, MHB9 and MHB12
- Supplied in 3.3m lengths

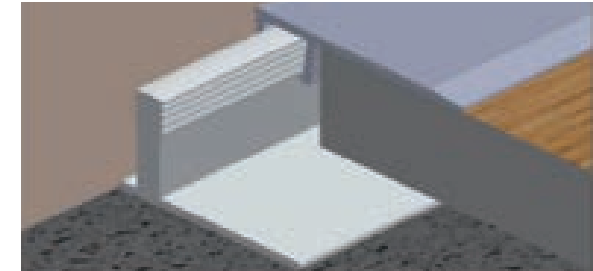
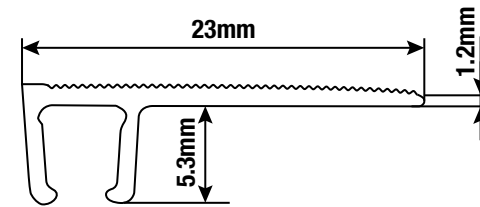

3.3 m LONG		23mm WIDE	
Colour	Code	Barcode	Pk Qty
Matt Silver	MHLT33NMS	9314942694779	10
Matt Bronze	MHLT33NMB	9314942694755	10
Matt Champagne	MHLT33NMC	9314942694762	10
Matt Black	MHLT33NMBL	9314942694748	10

Seamless Transition Cover

- Designed to give a seamless finish over the gap allowed for flooring expansion with a flat finish
- Protects carpet, laminate, timber or tile edges
- Available in Matt Silver, Matt Bronze, Matt Champagne, Matt Black, Pewter
- Silicone install only
- Supplied in 3.3m lengths

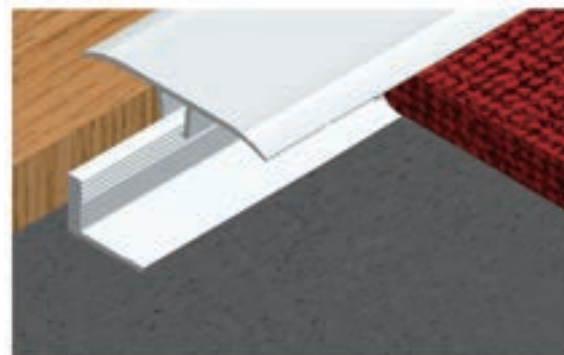
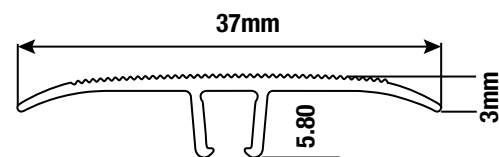

3.3 m LONG		37mm WIDE	
Colour	Code	Barcode	Pk Qty
Matt Silver	ACCP37.33NMS	9314942693703	10
Matt Bronze	ACCP37.33NMBR	9314942693680	10
Matt Champagne	ACCP37.33NMC	9314942693697	10
Matt Black	ACCP37.33NMBL	9314942693673	10

Multi-Height Bases



- Multi-height bases designed for use with seamless transition covers and seamless transition ramps
- Available in Plain
- Supplied in 3.3m lengths

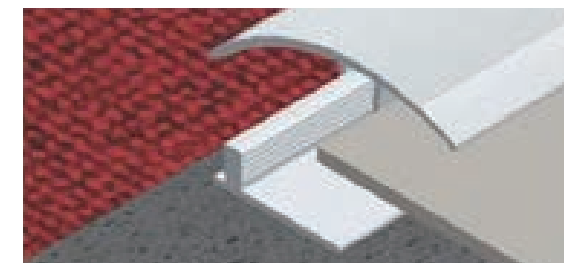
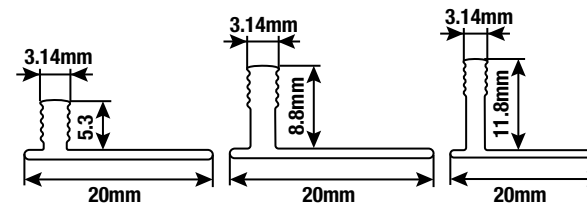

3.3 m LONG		5.3 mm HIGH	
Colour	Code	Barcode	Pk Qty
Plain	MHB5	9314942691983	10

3.3 m LONG		8.8 mm HIGH	
Colour	Code	Barcode	Pk Qty
Plain	MHB9	9314942693727	10

3.3 m LONG		11.8 mm HIGH	
Colour	Code	Barcode	Pk Qty
Plain	MHB12	9314942693727	10

Construction Cover 80mm

- Heavy duty expansion cover strip
- Available in Mill finish
- Supplied undrilled and without fixings
- Can be installed by drilling and countersinking or by using construction adhesive
- Supplied in 3.66m lengths

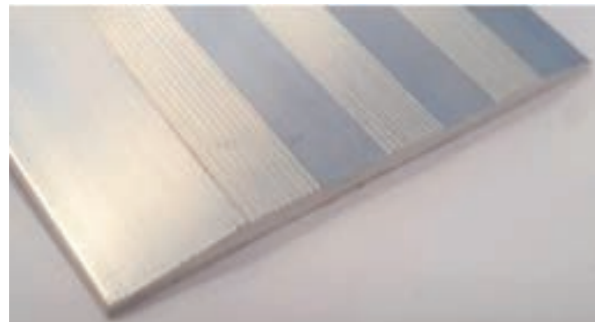
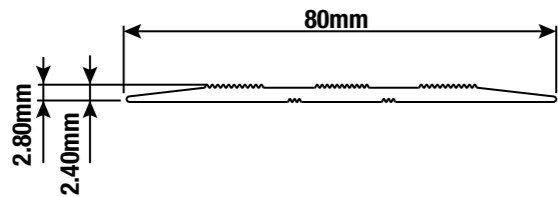

3.66m LONG		2.8mm HIGH	
Colour	Code	Barcode	Pk Qty
Mill Finish	ACC05	9314942691600	10

Construction Cover 100mm

- Heavy duty expansion cover strip
- Available in Mill finish
- Supplied undrilled and without fixings
- Can be installed by drilling and countersinking or by using construction adhesive
- Supplied in 3.66m lengths

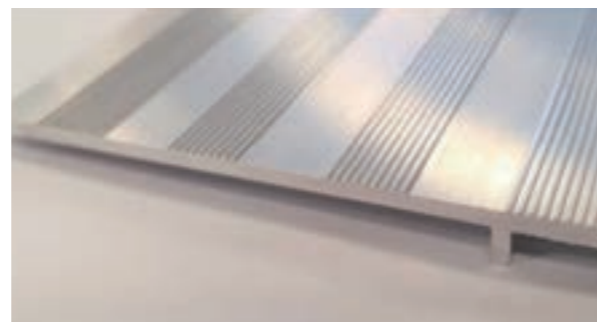
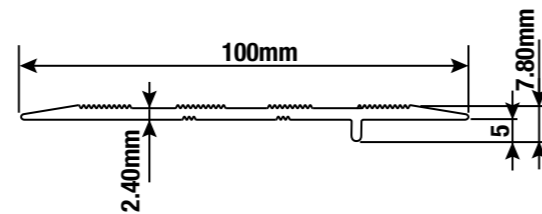

3.66m LONG		7.8mm HIGH	
Colour	Code	Barcode	Pk Qty
Mill Finish	ACC62	9314942691594	10

Retro-Fit Transition Profile



- Allows for a gradual transition between floor finishes
- Designed for a maximum Gradient of 1 in 8 to the requirements of AS1428-1:2009
- Tested to slip resistance standard AS 4586:2013 with a slip resistance rating of P3
- Available in 4 sizes
 - 5mm to 8mm drop (1 in 8 Gradient at 8mm drop)
 - 9mm to 12mm drop (1 in 8 Gradient at 12mm drop)
 - 13mm to 16mm drop (1 in 8 gradient at 16mm drop)
- Countersunk holes every 300mm
- Fast fitting and consistent finish
- Supplied countersunk with screws and plugs
- Available in Matt Silver Finish
- Supplied in 3m lengths

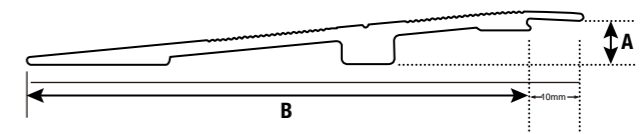

Size A	B
5mm	65mm
9mm	96mm
13mm	128mm



Colour	3.0m LONG		5mm HIGH		3.0m LONG		9mm HIGH		3.0m LONG		13mm HIGH		Pk Qty
	Code	Barcode	Code	Barcode	Code	Barcode	Code	Barcode	Code	Barcode			
Matt Silver	RTR3.05MS	9314942683810	RTR3.09MS	9314942683827	RTR3.13MS	9314942683834							10

Retro-Fit Transition Profile



- Allows for a gradual transition between floor finishes
- Designed for a maximum Gradient of 1 in 8 to the requirements of AS1428-1:2009
- Tested to slip resistance standard AS 4586:2013 with a slip resistance rating of P3
- Countersunk holes every 300mm
- Fast fitting and consistent finish
- For use with ASAT25X5 Anti-Slip Tape (sold separately) tested to slip resistance standard AS4586:2013 with a slip rating of P5
- Supplied countersunk with screws and plugs
- Available in Matt Silver Finish
- Supplied in 3.3m lengths

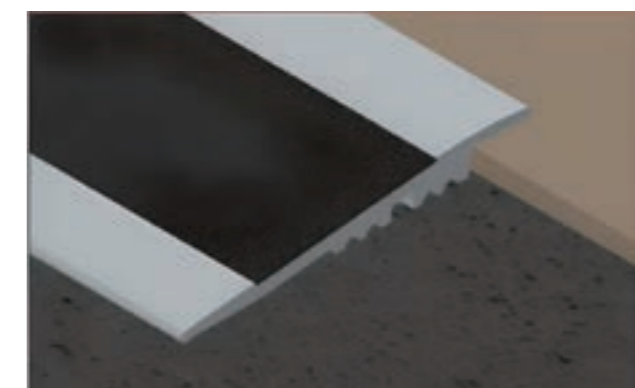
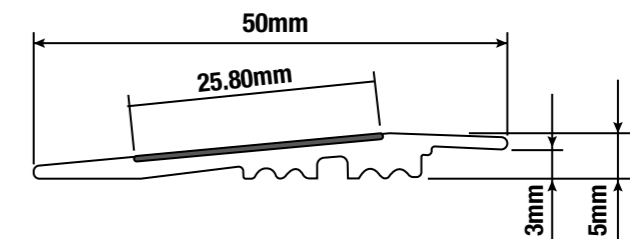

3.3m LONG		3mm HIGH	
Colour	Code	Barcode	Pk Qty
Matt Silver	RTR33.03NMS	9314942689935	10



TRANSITION PROFILES

TIMBER / LAMINATE PROFILES

Aluminium Transition Ramp



- Incline allows for a gradual transition from either concrete, wood floor or vinyl to protect the edge of the tile
- Ideal for domestic or commercial application
- Designed for a maximum Gradient of 1 in 8 to the requirements of AS1428-1:2009
- Tested to the requirements of AS 4586:2013 with a P5 Slip Resistance rating
- Can be used with ASAT25X5 Gecko Grip Tape (sold separately)
- Available in Plain and Matt Silver
- Supplied in 3m lengths

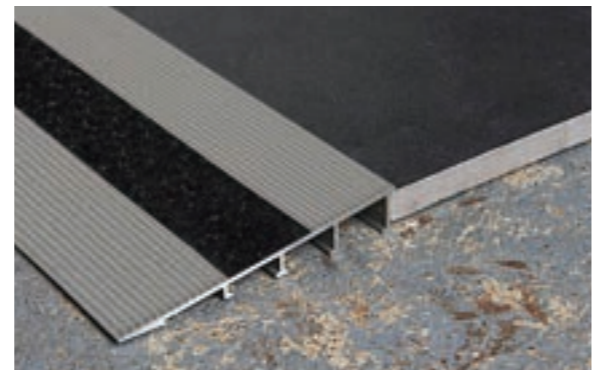

* Picture shown with Gecko Grip Tape installed (sold separately)

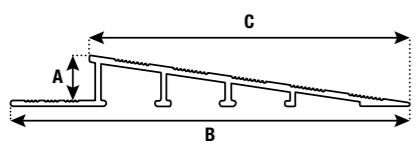

Size A	B	C
8mm	96mm	74mm
10mm	112mm	90mm
12mm	132mm	110mm

Colour	3.0m LONG 8mm HIGH		3.0m LONG 10mm HIGH		3.0m LONG 12mm HIGH		Pk Qty
	Code	Barcode	Code	Barcode	Code	Barcode	
Plain	ATSE3.074-08	9314942685814	ATSE3.090-10	9314942685821	ATSE3.110-12	9314942685838	10
Matt Silver	ATSE3.074-08MS	9314942687467	ATSE3.090-10MS	9314942687474	ATSE3.110-12MS	9314942685845	10



TIMBER / LAMINATE PROFILES

Designed to finish off your laminate and timber floors, DTA have a range of end covers to complement your flooring.



End Cover for Laminated / Floating Floor



- To provide protection to raw laminate edges giving a professional clean finish
- Allows for neat transition between laminate and carpet
- Tested to the requirements of AS 4586:2013 with a P4 Slip Resistance rating
- Available in Matt Silver, Matt Bronze, Matt Black and Matt Champagne
- Supplied in 3.3m lengths

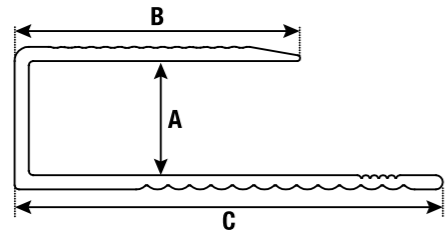

Size A	B	C
5.5mm	13.6mm	23mm
6.7mm	13.6mm	23mm
8mm	18mm	25mm
13mm	18mm	25mm
15mm	18mm	25mm

		3.3m LONG		5.5mm HIGH	
Colour		Code	Barcode	Pk Qty	
	Matt Silver	LFEC33.05NMS	9314942689904	10	
	Matt Bronze	LFEC33.05NMB	9314942689911	10	
	Matt Black	LFEC33.05NMBL	9314942689942	10	
	Matt Champagne	LFEC33.05NMC	9314942692812	10	

		3.3m LONG		6.7mm HIGH		3.3m LONG		8mm HIGH	
Colour		Code	Barcode	Pk Qty		Code	Barcode	Pk Qty	
	Matt Silver	LFEC33.06NMS	9314942690795	10		LFEC33.08NMS	9314942687672	10	
	Matt Bronze	LFEC33.06NMB	9314942690801	10		LFEC33.08NMB	9314942687658	10	
	Matt Black	LFEC33.06NMBL	9314942690818	10		LFEC33.08NMBL	9314942687641	10	
	Matt Champagne	LFEC33.06NMC	9314942690825	10		LFEC33.08NMC	9314942687665	10	

		3.3m LONG		13mm HIGH		3.3m LONG		15mm HIGH	
Colour		Code	Barcode	Pk Qty		Code	Barcode	Pk Qty	
	Matt Silver	LFEC33.13NMS	9314942687719	10		LFEC33.15NMS	9314942687757	10	
	Matt Bronze	LFEC33.13NMB	9314942687696	10		LFEC33.15NMB	9314942687733	10	
	Matt Black	LFEC33.13NMBL	9314942687689	10		LFEC33.15NMBL	9314942687726	10	
	Matt Champagne	LFEC33.13NMC	9314942687702	10		LFEC33.15NMC	9314942687740	10	

Edge Cover Transition



- Landing edge transition for hybrid vinyl planks
- Available in Matt Silver, Matt Bronze, Matt Black and Matt Champagne
- Supplied in 3.3m lengths

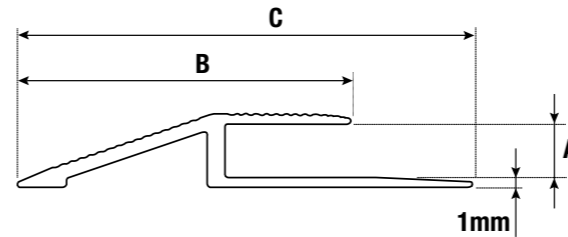

Size A	B	C
5.5mm	34mm	46.40mm
6.7mm	38.5mm	50.9mm

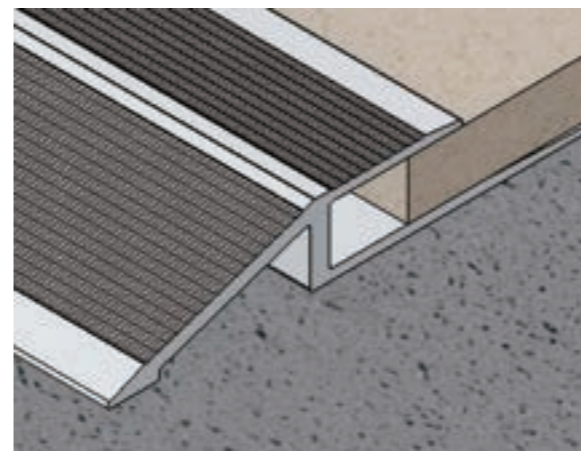

		3.3m LONG		6.7mm HIGH	
Colour		Code	Barcode	Pk Qty	
	Matt Silver	LFET33.06NMS	9314942691976	10	
	Matt Bronze	LFET33.06NMB	9314942691952	10	
	Matt Black	LFET33.06NMBL	9314942691945	10	
	Matt Champagne	LFET33.06NMC	9314942691969	10	

		3.3m LONG		5.5mm HIGH	
Colour		Code	Barcode	Pk Qty	
	Matt Silver	LFET33.05NMS	9314942689928	10	
	Matt Bronze	LFET33.05NMB	9314942691136	10	
	Matt Black	LFET33.05NMBL	9314942691143	10	
	Matt Champagne	LFET33.05NMC	9314942692829	10	

L-Shape End Cover



- Designed to provide protection to raw laminate/floating floor edges giving a professional clean finish
- Can be retro fitted after installation of flooring
- Tested to the requirements of AS 4586:2013 with a P4 Slip Resistance rating
- Available in Matt Silver, Matt Bronze, Matt Black and Matt Champagne
- 3.3m lengths must be purchased in packs of 10

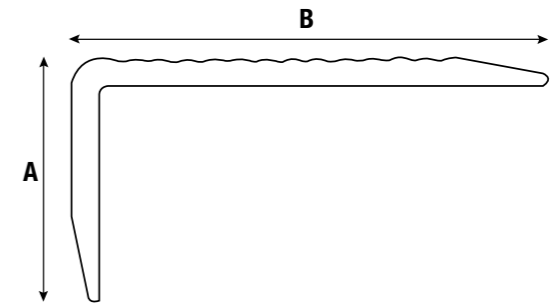

Size A	B
9.3mm	18mm
5mm	18mm



		3.3m LONG		9.3mm HIGH	
Colour		Code	Barcode	Pk Qty	
	Matt Silver	LECT33.08NMS	9314942687795	10	
	Matt Bronze	LECT33.08NMB	9314942687771	10	
	Matt Black	LECT33.08NMBL	9314942687764	10	
	Matt Champagne	LECT33.08NMC	9314942687788	10	

		3.3m LONG		5mm HIGH	
Colour		Code	Barcode	Pk Qty	
	Matt Silver	LECT33.05NMS	9314942690948	10	
	Matt Bronze	LECT33.05NMB	9314942690917	10	
	Matt Black	LECT33.05NMBL	9314942690924	10	
	Matt Champagne	LECT33.05NMC	9314942690931	10	



TIMBER / LAMINATE PROFILES

TIMBER / LAMINATE PROFILES



CARPET PROFILES

The DTA range of heavy duty carpet profiles are used predominantly in door jambs and larger open areas to secure carpet edges directly to the floor, giving a complete professional finish.

Nap-Down Domestic Hammered Pinned

- Hammer finish would be suited to a more traditional design
- Available in Mill Finish, Matt Bronze, Matt Black, Matt Champagne, Matt Silver and Pewter
- Supplied in 3.3m lengths

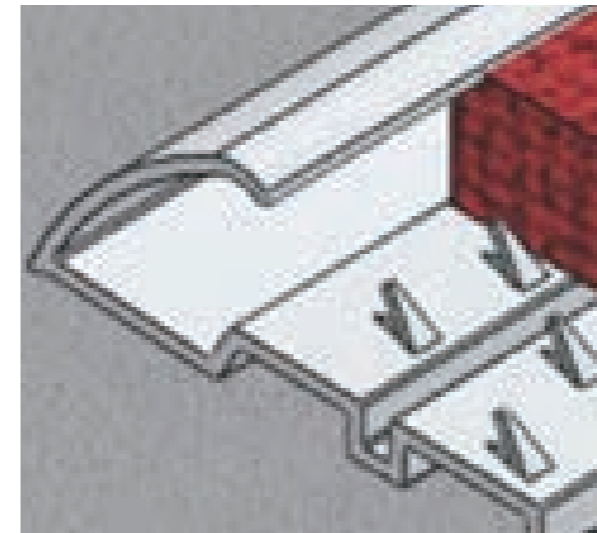
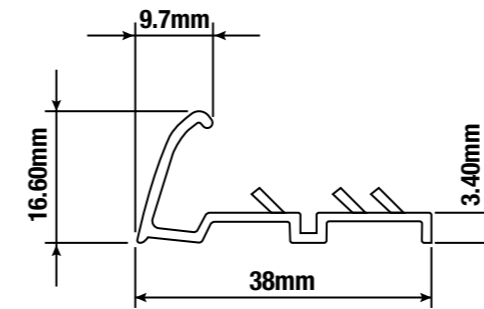

3.3m LONG 38mm WIDE

Colour	Code	Barcode	Pk Qty
	ACEHP33.15	9314942690795	10
	ACEHP33.15NMB	9314942691662	10
	ACEHP33.15NMBL	9314942691655	10
	ACEHP33.15NMC	9314942691679	10
	ACEHP33.15NMS	9314942691693	10
	ACEHP33.15NPE	9314942691686	10

Nap-Down Commercial Hammered Pinned

- Used with conventionally installed carpets in commercial or high traffic areas
- Available in Mill Finish
- Supplied in 3.3m lengths

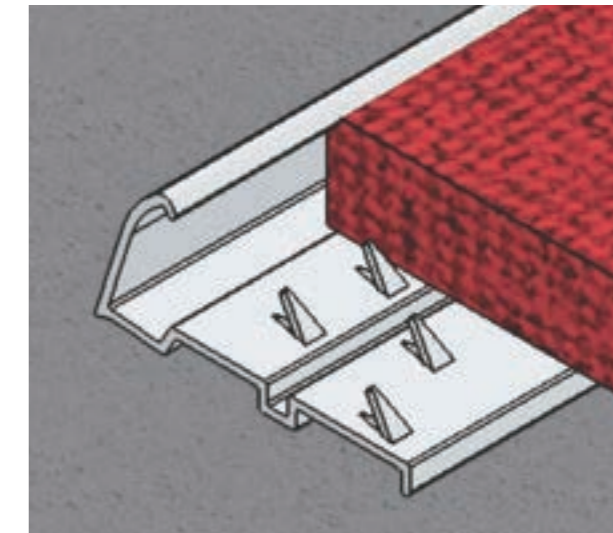
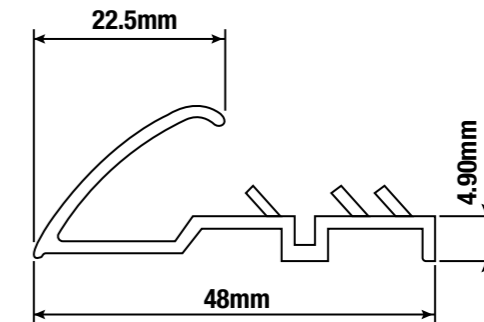

3.66 m LONG 38mm WIDE

Colour	Code	Barcode	Pk Qty
	ACEHP36.19	9314642691723	10



Nap-Down Commercial Hammered Pinless

- Hammer finish would be suited to a more traditional design
- Available in Mill Finish
- Supplied in 3.66m lengths

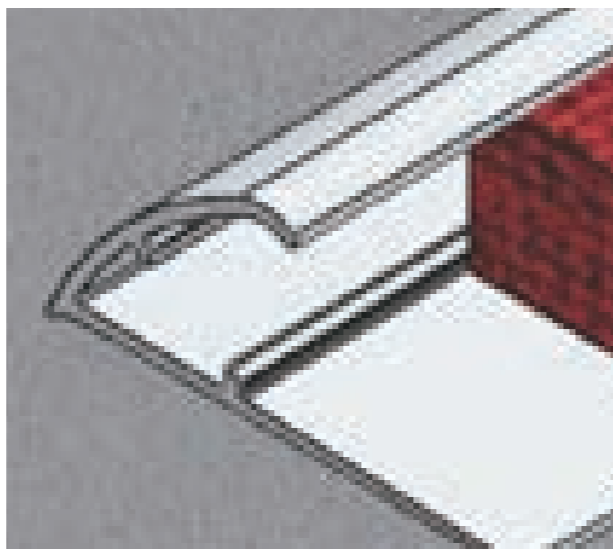
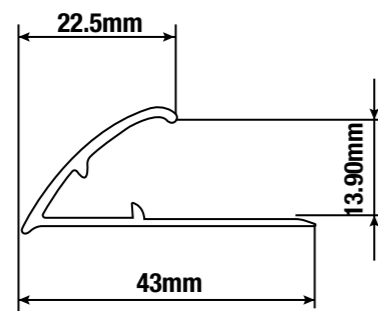

3.66 m LONG		43mm WIDE	
Colour	Code	Barcode	Pk Qty
Mill Finish	ACEH36.18	9314942691716	10

Formable L-Shape Profiles

- Formable angle is ideal for tiles with a curve
- Can be used on floor and wall
- Can be used as an edge protection of tiled floors
- Available in Plain, Black and White
- Supplied in 3m lengths

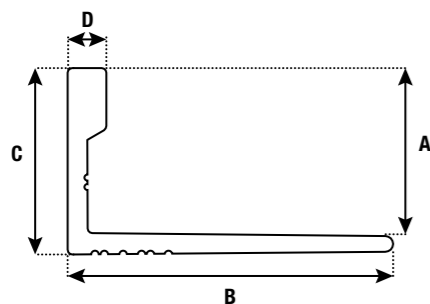

Size A	B	C	D
4.5mm	21mm	5.2mm	2.5mm
6mm	21mm	7.2mm	2.5mm
8mm	21mm	9.2mm	2.5mm
10mm	21mm	11.2mm	2.5mm
12.5mm	21mm	13.7mm	2.5mm
15mm	21mm	16.2mm	2.5mm

Colour	4.5mm Code	6mm Code	8mm Code	10mm Code	12.5mm Code	15mm Code	Pk Qty
Plain	ALAF3.04	ALAF3.06	ALAF3.08	ALAF3.10	ALAF3.12	ALAF3.15	20
Black	ALAF3.04BK	ALAF3.06BK	ALAF3.08BK	ALAF3.10BK	ALAF3.12BK		20
White	ALAF3.04NW	ALAF3.06NW	ALAF3.08NW	ALAF3.10NW	ALAF3.12NW		20

Aluminium L-Shape Profile

- Aluminium angle for tile edge protection
- Used where tile meets carpet, wooden floors etc.
- Creates an attractive finish if used on external corners
- Available in wide range of colours
- Supplied in 1m and 3m lengths

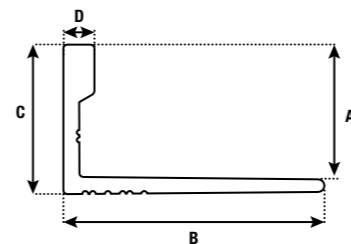

Size A	B	C	D
4.5mm	21mm	5.2mm	2.5mm
6mm	21mm	7.2mm	2.5mm
8mm	21mm	9.2mm	2.5mm
9mm	21mm	10.2mm	2.5mm
10mm	21mm	11.2mm	2.5mm
11mm	21mm	12.5mm	2.5mm
12.5mm	21mm	13.7mm	2.5mm
15mm	21mm	16.2mm	2.5mm
18.5mm	21mm	19.7mm	2.5mm
20mm	21mm	23.2mm	2.5mm
22mm	21mm	21.2mm	2.5mm
25mm	21mm	26.2mm	2.5mm



1metre Colour	4.5mm Code	6mm Code	8mm Code	9mm Code	10mm Code	11mm Code	12.5mm Code	15mm Code	18.5mm Code	22mm Code	Pk Qty
Plain	ALA1.04	ALA1.06	ALA1.08	ALA1.09	ALA1.10	ALA1.11	ALA1.12	ALA1.15	ALA1.18	ALA1.22	20

3metre Colour	4.5mm Code	6mm Code	8mm Code	9mm Code	10mm Code	11mm Code	12.5mm Code	13mm Code	15mm Code	18.5mm Code	20mm Code	22mm Code	25mm Code	Pk Qty
Plain	ALA3.04	ALA3.06	ALA3.08	ALA3.09	ALA3.10	ALA3.11	ALA3.12	ALA3.13	ALA3.15	ALA3.18	ALA3.20	ALA3.22	ALA3.25	20
Matt Silver	ALA3.04MS	ALA3.06MS	ALA3.08MS	ALA3.09MS	ALA3.10MS	ALA3.11MS	ALA3.12MS	ALA3.13MS	ALA3.15MS	ALA3.18MS	ALA3.20MS	ALA3.22MS	ALA3.25MS	20
Brush Nickel	ALA3.04BN	ALA3.06BN	ALA3.08BN	ALA3.09BN	ALA3.10BN	ALA3.11BN	ALA3.12BN	ALA3.13BN	ALA3.15BN	ALA3.18BN	ALA3.20BN	ALA3.22BN	ALA3.25BN	20
Bright Silver	ALA3.04BS	ALA3.06BS	ALA3.08BS	ALA3.09BS	ALA3.10BS	ALA3.11BS	ALA3.12BS	ALA3.13BS	ALA3.15BS	ALA3.18BS	ALA3.20BS	ALA3.22BS	ALA3.25BS	20
Bright Gold		ALA3.06BG	ALA3.08BG	ALA3.09BG	ALA3.10BG	ALA3.11BG	ALA3.12BG		ALA3.15BG	ALA3.18BG				20
Black	ALA3.04BK	ALA3.06BK	ALA3.08BK	ALA3.09BK	ALA3.10BK	ALA3.11BK	ALA3.12BK		ALA3.15BK	ALA3.18BK		ALA3.22BK		20
White	ALA3.04W	ALA3.06W	ALA3.08W	ALA3.09W	ALA3.10W	ALA3.11W	ALA3.12W		ALA3.15W	ALA3.18W		ALA3.22W		20
Brush Black		ALA3.06BFK	ALA3.08BFK		ALA3.10BFK	ALA3.11BFK	ALA3.12BFK		ALA3.15BFK		ALA3.20BFK		ALA3.25BFK	20
Matt Black	ALA3.04MBL	ALA3.06MBL	ALA3.08MBL	ALA3.09MBL	ALA3.10MBL	ALA3.11MBL	ALA3.12MBL		ALA3.15MBL	ALA3.18MBL	ALA3.20MBL	ALA3.22MBL		20
Matt White	ALA3.04MW	ALA3.06MW	ALA3.08MW	ALA3.09MW	ALA3.10MW	ALA3.11MW	ALA3.12MW		ALA3.15MW	ALA3.18MW	ALA3.20MW	ALA3.22MW		20
Brushed Light Gold			ALA3.08BFL		ALA3.10BFL	ALA3.11BFL	ALA3.12BFL		ALA3.15BFL					20
Matt Gold			ALA3.08MG		ALA3.10MG	ALA3.11MG	ALA3.12MG		ALA3.15MG					20
Brushed Copper		ALA3.06BFC	ALA3.08BFC	ALA3.09BFC	ALA3.10BFC	ALA3.11BFC	ALA3.12BFC		ALA3.15BFC					20
Brushed Gunmetal		ALA3.06BFGM	ALA3.08BFGM	ALA3.09BFGM	ALA3.10BFGM	ALA3.11BFGM	ALA3.12BFGM		ALA3.15BFGM					20

Carpet Tile Edge



- Allows for gradual transition from carpet tile to the substrate
- Available in Mill Finish and Matt Black
- Supplied in 3.66m lengths

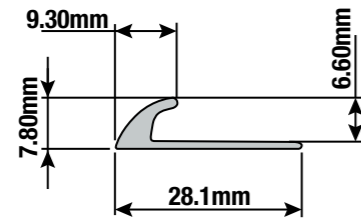

3.66m LONG		7.8mm HIGH	
Colour	Code	Barcode	Pk Qty
	Mill Finish	CTE03	9314942691914 10
	Matt Black	CTE03NMBL	9314942697855 10

Carpet Tile Diminishing Strip



- Allows for gradual transition from carpet tile to the substrate
- Available in Mill Finish
- Supplied in 3.66m lengths

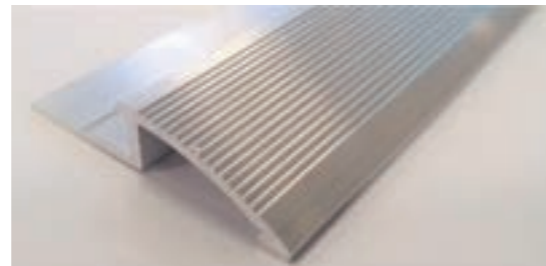
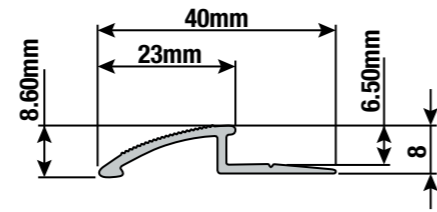

3.66m LONG		8.6mm HIGH	
Colour	Code	Barcode	Pk Qty
	Mill Finish	CTE59	9314942691921 10

Multi Trim Base Pinless



- Used for timber and hard floors
- Use in conjunction with multi trim cover
- Available in Plain
- Supplied in 1m and 3.3m lengths

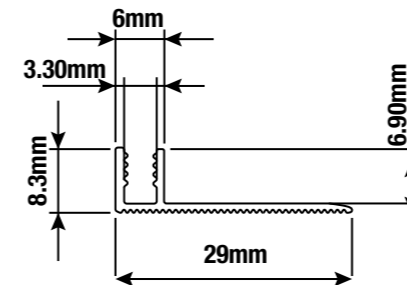

1.0m LONG		8.3mm HIGH	
Colour	Code	Barcode	Pk Qty
	Plain	MTB1	9314942669661 20

3.3m LONG		8.3mm HIGH	
Colour	Code	Barcode	Pk Qty
	Plain	MTB33	9314942669654 20

Multi Trim Base Pinned



- Used for carpet
- Use in conjunction with multi trim cover
- Available in Plain
- Supplied in 1m and 3.3m lengths

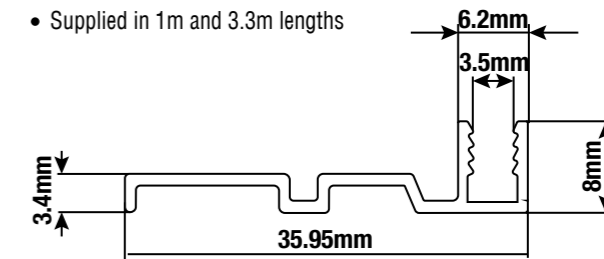

3.3m LONG		8.8mm HIGH	
Colour	Code	Barcode	Pk Qty
	Plain	MTBP33	9314942669678 5

Multi Extension Channel



- Used for carpet
- Use in conjunction with multi trim cover
- Available in Mill Finish
- Supplied in 3.3m lengths

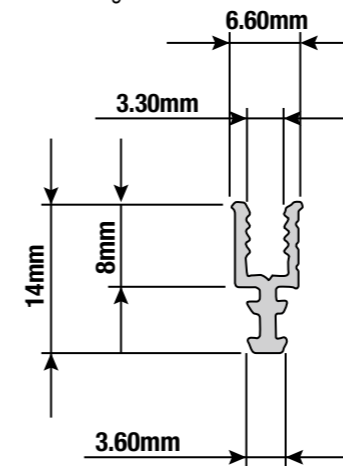

3.3m LONG		14mm LONG	
Colour	Code	Barcode	Pk Qty
	Mill Finish	MTBEC33	9314942691648 20

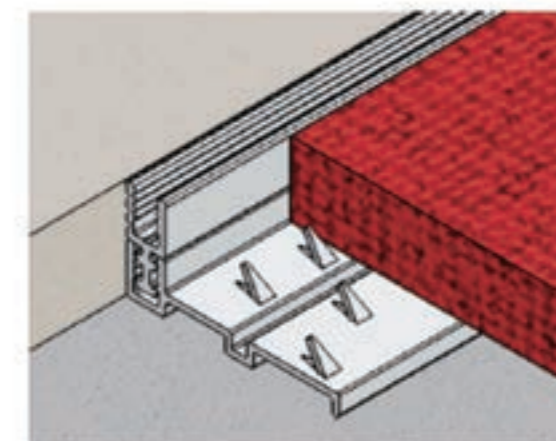
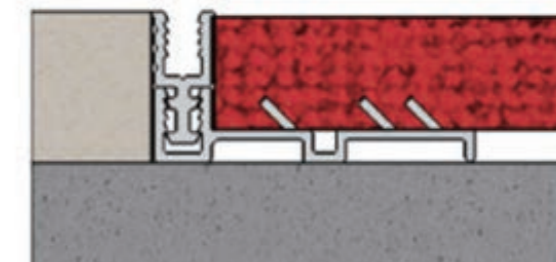



STAIR EDGE PROFILES

DTA stair edge profiles are designed for the protection of stair edges in both the residential and commercial markets. Easily applied over carpet, timber, tile or vinyl.

Stair Nosing Short Riser



- Universal stair nosing with short riser
 - Countersink drilled at 200mm spacing with screws & plugs (sold separately)
 - Insert channel 51mm
 - Designed for use with anti-slip tape or ASN152 insert
 - Available in Matt Silver anodised finish
 - Supplied in 3.66m lengths
- Compliance**
- Profile designed to comply with AS1428.1-2021
 - Used with insert ASN152 or Gecko Anti-slip tape for compliance with AS4586:2013

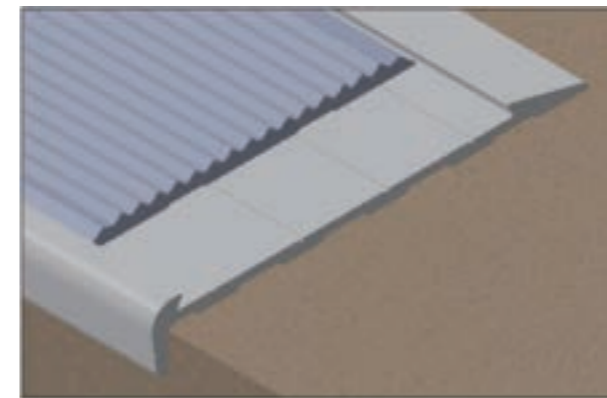
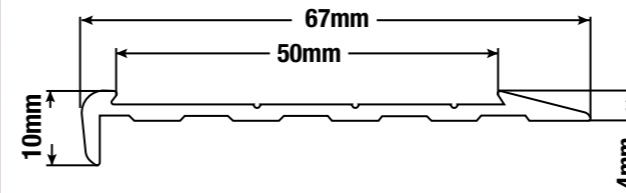

3.66m LONG | 67mm WIDE

Colour	Code	Barcode	Pk Qty	
	Matt Silver	ASN111NMS	9314942689621	10

Stair Nosing Long Riser



- Countersink drilled at 200mm spacing with screws & plugs (sold separately)
 - Insert channel 51mm
 - Designed for use with anti-slip tape or ASN152 insert
 - Available in Matt Silver and Matt Black anodised finish
 - Supplied in 3.66m lengths
- Compliance**
- Profile colour selection required for compliance with AS1428.1-2021
 - Use with insert ASN152 or Gecko Anti-slip tape for compliance with AS4586:2013

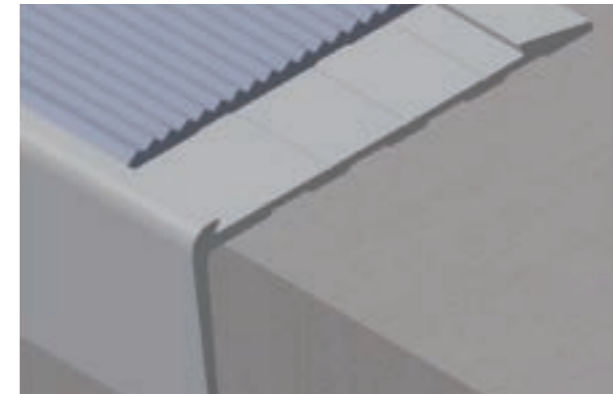
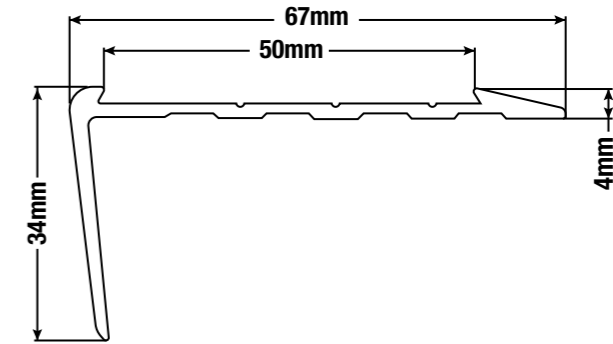

3.66m LONG | 34mm HIGH

Colour	Code	Barcode	Pk Qty	
	Matt Silver	ASN75NMS	9314942689638	10
	Matt Black	ASN75NMBL	9314942689645	10

Stair Nosing Vinyl Short Riser



- Vinyl nosing with short riser
- Countersink drilled at 200mm spacing with screws & plugs (sold separately)
- Insert channel 51mm
- Designed for use with anti-slip tape or ASN152 insert
- Available in Matt Silver anodised finish
- Supplied in 3.66m lengths

Compliance

- Profile designed to comply with AS1428.1-2021
- Used with insert ASN152 or Gecko Anti-slip tape for compliance with AS4586:2013

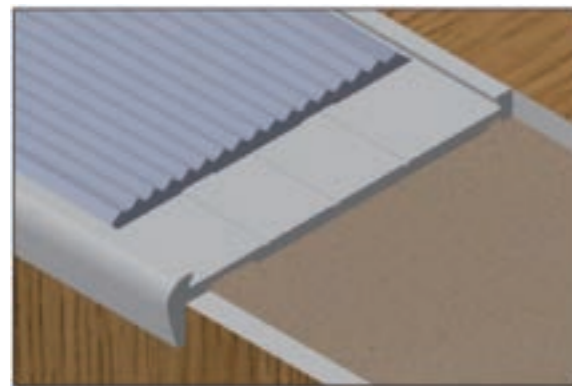
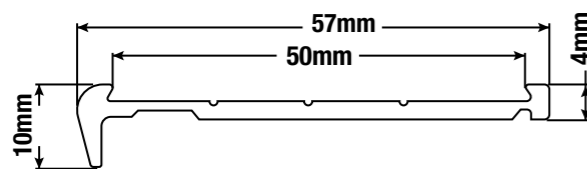

Stair Nosing Vinyl Long Riser



- Vinyl nosing with long riser
- Countersink drilled at 200mm spacing with screws & plugs (sold separately)
- Insert channel 51mm
- Designed for use with anti-slip tape or ASN152 insert
- Available in Matt Silver anodised finish
- Supplied in 3.66m lengths

Compliance

- Profile colour selection required for compliance with AS1428.1-2021
- Use with insert ASN152 or Gecko Anti-slip tape for compliance with AS4586:2013

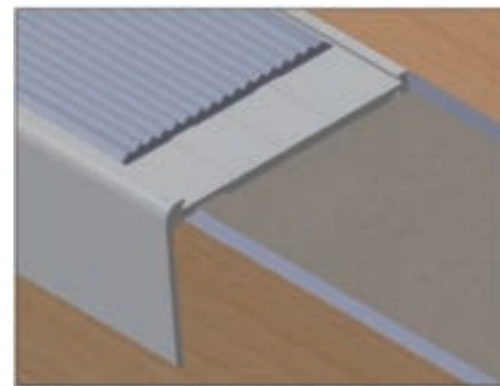
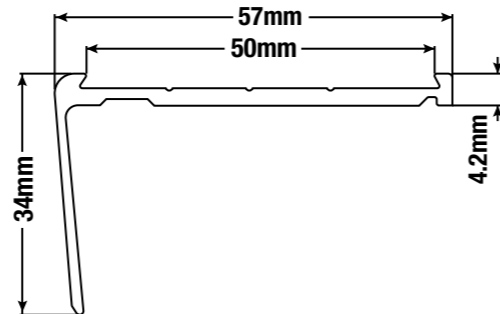

Stair Nosing Carpet Short Riser



- Carpet nosing with short riser
- Countersink drilled at 200mm spacing with screws & plugs (sold separately)
- Insert channel 51mm
- Designed for use with anti-slip tape or ASN152 insert
- Available in Matt Silver anodised finish
- Supplied in 3.66m lengths

Compliance

- Profile designed to comply with AS1428.1-2021
- Used with insert ASN152 or Gecko Anti-slip tape for compliance with AS4586:2013

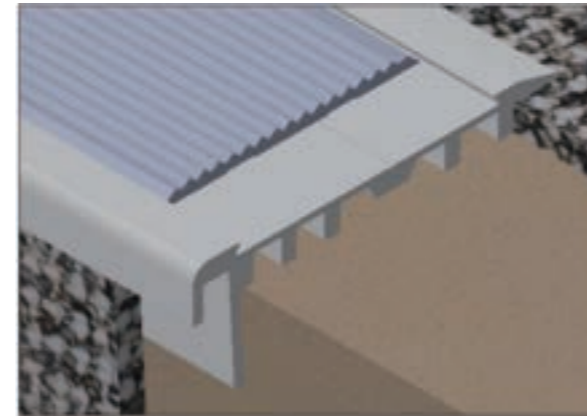
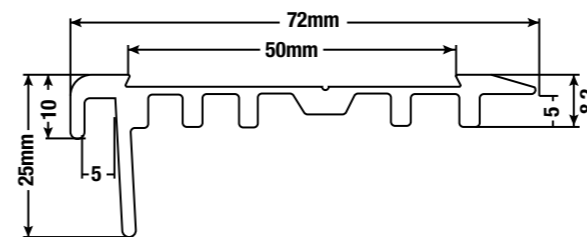

Stair Nosing Carpet Long Riser



- Carpet nosing with long riser
- Countersink drilled at 200mm spacing with screws & plugs (sold separately)
- Insert channel 51mm
- Designed for use with anti-slip tape or ASN152 insert
- Available in Matt Silver and Matt Black anodised finish
- Supplied in 3.66m lengths

Compliance

- Profile colour selection required for compliance with AS1428.1-2021
- Use with insert ASN152 or Gecko Anti-slip tape for compliance with AS4586:2013

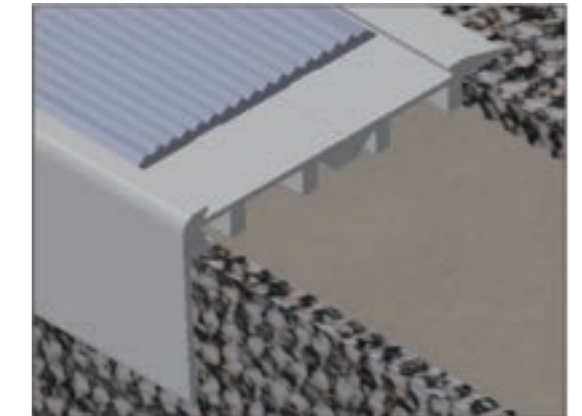
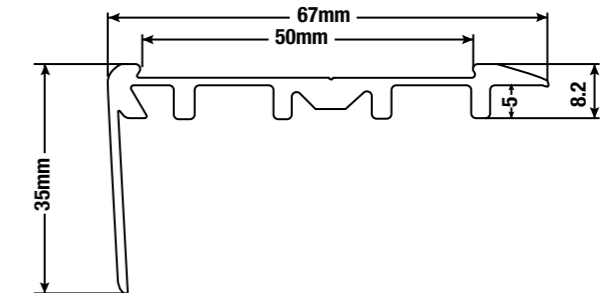

3.66m LONG | 57mm WIDE

Colour	Code	Barcode	Pk Qty
Matt Silver	ASN150NMS	9314942689652	10

3.66m LONG | 34mm HIGH

Colour	Code	Barcode	Pk Qty
Matt Silver	ASN52NMS	9314942689669	10
Matt Black	ASN52NMBL	9314942689676	10

3.66m LONG | 25mm HIGH

Colour	Code	Barcode	Pk Qty
Matt Silver	ASN151NMS	9314942689683	10

3.66m LONG | 35mm HIGH

Colour	Code	Barcode	Pk Qty
Matt Silver	ASN58NMS	9314942689690	10
Matt Black	ASN58NMBL	9314942689706	10

Rebated Nosing Plate

TRADE

- Designed for installation in rebated channel
- Countersink drilled at 200mm spacing with screws & plugs (sold separately)
- Insert channel 51mm
- Designed for use with anti-slip tape or AS152 insert
- Available in Matt Silver anodised finish
- Supplied in 3.66m lengths

Compliance

- Profile designed to comply with AS1428.1-2021
- Used with insert ASN152 or Gecko Anti-slip tape for compliance with AS4586:2013

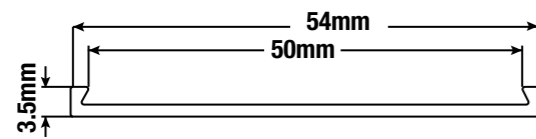

3.66m LONG 54mm WIDE

Colour	Code	Barcode	Pk Qty
Matt Silver	ASN153NMS	9314942689737	10

Aluminium Stair Nosing Insert

TRADE

- Nosing for stair edging
- Can be used in conjunction with stair nosing requiring an insert
- Available in Matt Silver and Matt Black anodised finish
- Supplied in 3.66m lengths

Compliance

- Profile designed to comply with AS1428.1-2009
- Tested to the requirements of AS4586:2013 with a P4 Slip Resistance rating

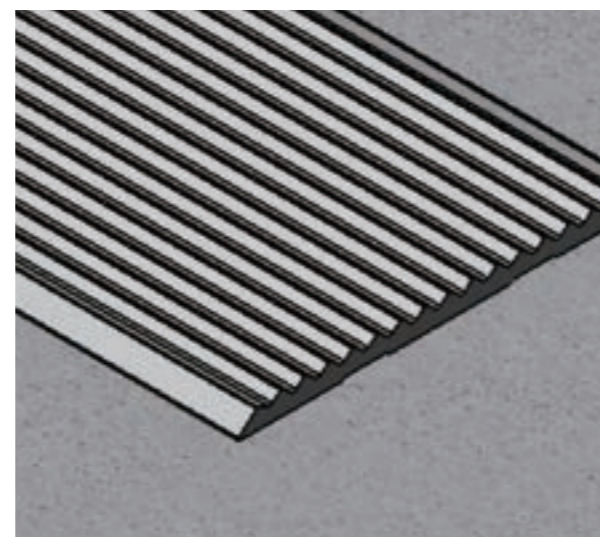
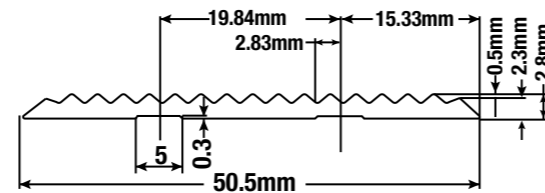

3.66m LONG 50.5mm WIDE

Colour	Code	Barcode	Pk Qty
Matt Silver	ASN152NMS	9314942689713	10
Matt Black	ASN152NMBL	9314942689720	10

All Weather Stair Nosing

TRADE

- Designed for outdoor and rugged applications
- Waterproof
- Engraved with high slip resistant black silicon carbide
- Countersink drilled at 200mm spacing with screws & plugs (sold separately)
- Ideal for demanding environments
- Available in Matt Silver finish
- Supplied in 3.66m lengths

Compliance

- Tested to the requirements of AS4586:2013 with a P5 Slip Resistance rating

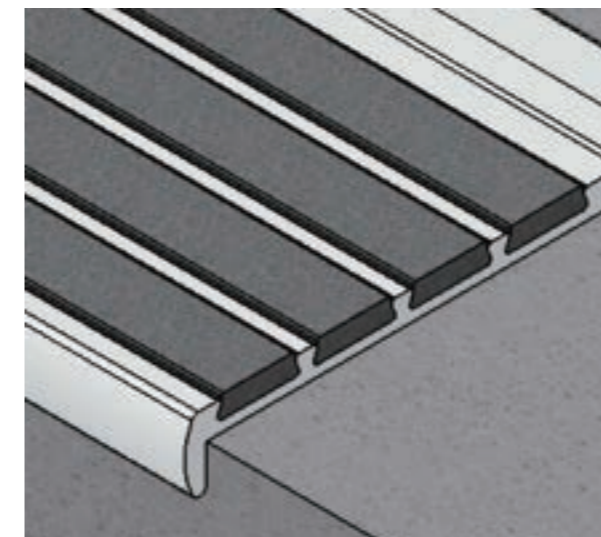
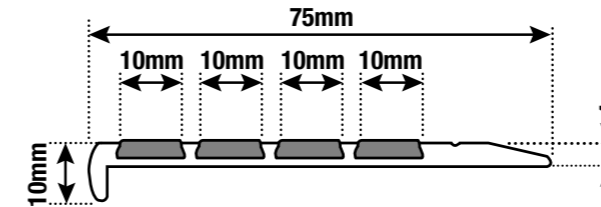

3.66m LONG 75mm WIDE

Colour	Code	Barcode	Pk Qty
Matt Silver	ASN154NMS	9314942689744	10

All Weather Stair Nosing With Luminance Strip

TRADE

- Illumination strip
- Designed for outdoor and rugged applications
- Waterproof
- Engraved with high slip resistant black silicone carbide
- Countersink drilled at 200mm spacing with screws & plugs (sold separately)
- Ideal for demanding environments
- Available in Matt Silver finish
- Supplied in 3.66m lengths

Compliance

- Tested to the requirements of AS4586:2013 with a P5 Slip Resistance rating

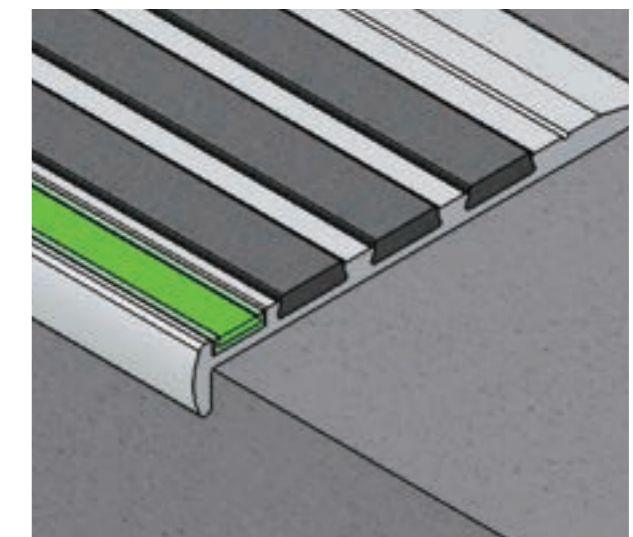
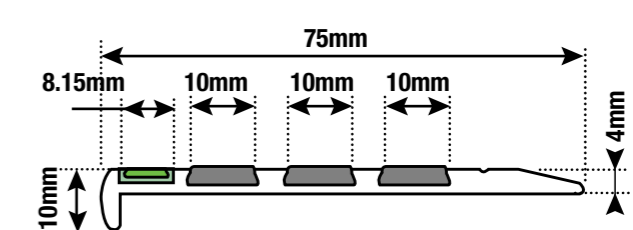

3.66m LONG 75mm WIDE

Colour	Code	Barcode	Pk Qty
Matt Silver	ASN155NMS	9314942689751	10

Bullnose Stair Nosing

TRADE

- Nosing for stair edging
- Countersink drilled at 200mm spacing with screws & plugs (sold separately)
- Insert channel 51mm
- Designed for use with anti-slip tape or ASN152 insert
- Available in Matt Silver and Matt Black anodised finish
- Supplied in 3.66m lengths

Compliance

- Use with insert ASN152 or Gecko Anti-slip tape for compliance with AS4586:2013

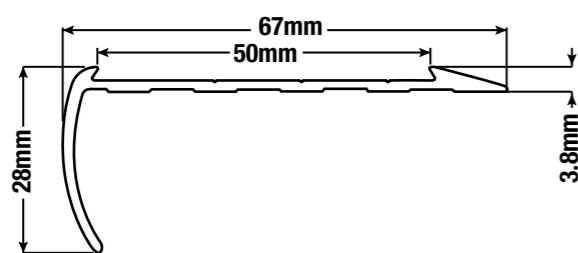

3.66m LONG 67mm WIDE

Colour	Code	Barcode	Pk Qty
Matt Silver	ASN56NMS	9314942689829	10
Matt Black	ASN56NMBL	9314942689836	10

Sawtooth Stair Nosing

TRADE

- Ideal protection for stairs
- 50mm tread to protect carpet, vinyl, timber or tile edges
- Countersink drilled at 200mm spacing with screws & plugs (sold separately)
- Available in Plain and Matt Silver anodised finish
- Supplied in 3.66m lengths

Compliance

- Tested to the requirements of AS4586:2013 with a P5 Slip Resistance rating

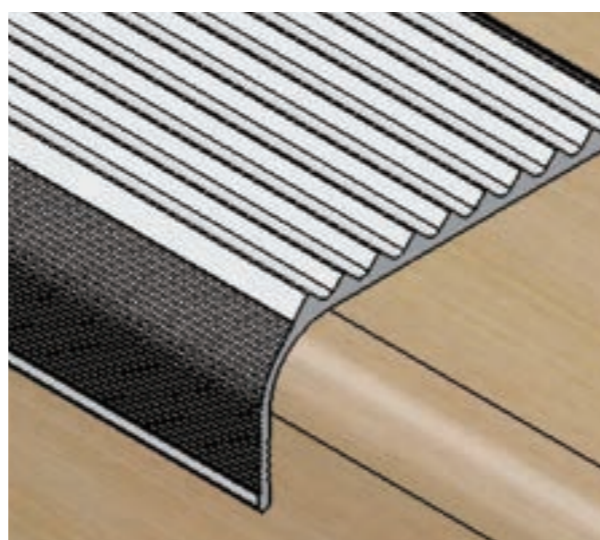
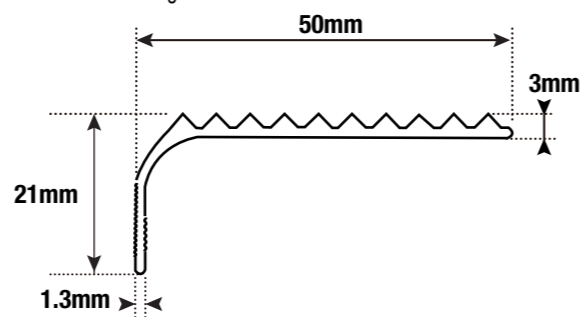

3.66m LONG 50mm WIDE

Colour	Code	Barcode	Pk Qty
Mill Finish	ASN51	9314942692904	10
Matt Silver	ASN51NMS	9314942689843	10

Stair Nosing Self Adhesive

TRADE

- Aluminium stair nosing profile
- Comes with industrial strength adhesive tape application
- Available in Matt Silver, Matt Bronze, Matt Black, Matt Champagne and Pewter anodised finish
- Supplied in 3.3m lengths

Compliance

- Tested to the requirements of AS4586:2013 with a P3 Slip Resistance rating

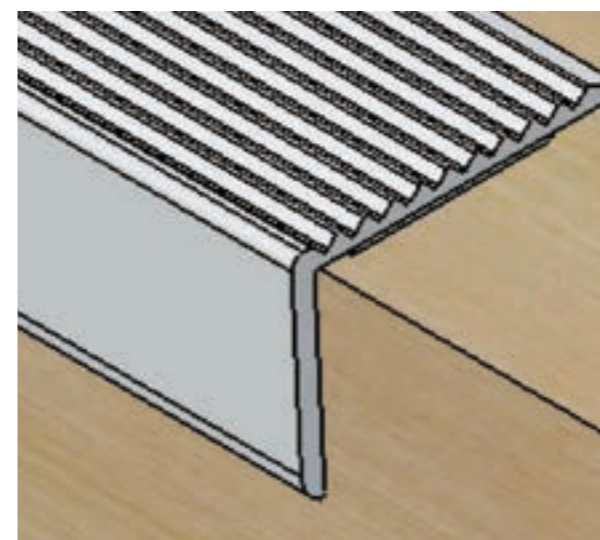
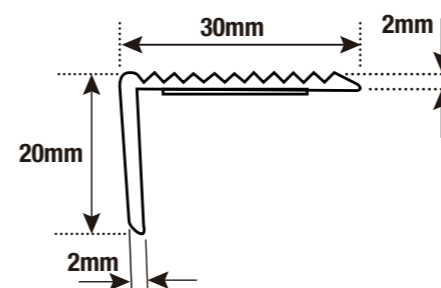

3.3m LONG 30mm WIDE

Colour	Code	Barcode	Pk Qty
Matt Silver	ASN156NMS	9314942689874	10
Matt Bronze	ASN156NMB	9314942691129	10
Matt Black	ASN156NMBL	9314942689881	10
Matt Champagne	ASN156NMC	9314942691112	10
Pewter	ASN156NPE	9314942692164	10

Light Bullnose Stair Nosing Self Adhesive

TRADE

- Available in Matt Silver anodised finish with black silicone carbide anti slip
- Comes with industrial strength adhesive tape
- supplied for easy application
- Supplied in 3.3m lengths

Compliance

- Tested to the requirements of AS4586:2013 with a P5 Slip Resistance rating

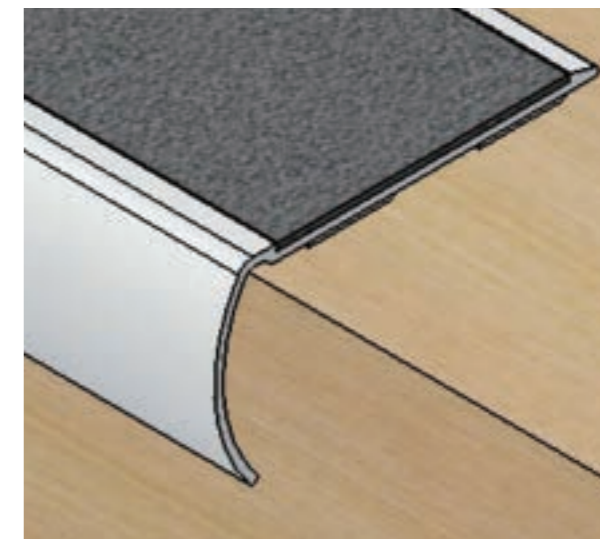
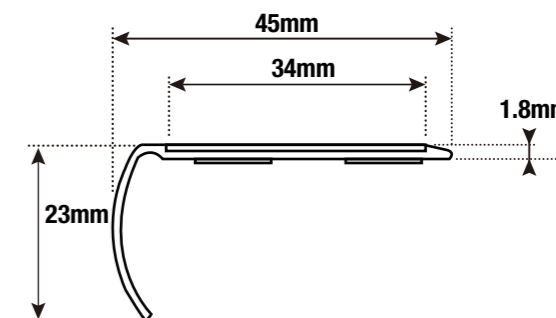

3.3m LONG 30mm WIDE

Colour	Code	Barcode	Pk Qty
Matt Silver	ASN157NMS	9314942689898	10

Stair Nosing Profile Hammer Finish

- Ideal protection for stairs
- Protects carpet, vinyl, timber or tile edges
- Countersink drilled at 200mm spacing with nails
- Available in Matt Silver, Matt Bronze, Pewter and Matt Black anodised
- Supplied in 3.3m lengths



Compliance

- Tested to the requirements of AS4586:2013 with a P3 Slip Resistance rating

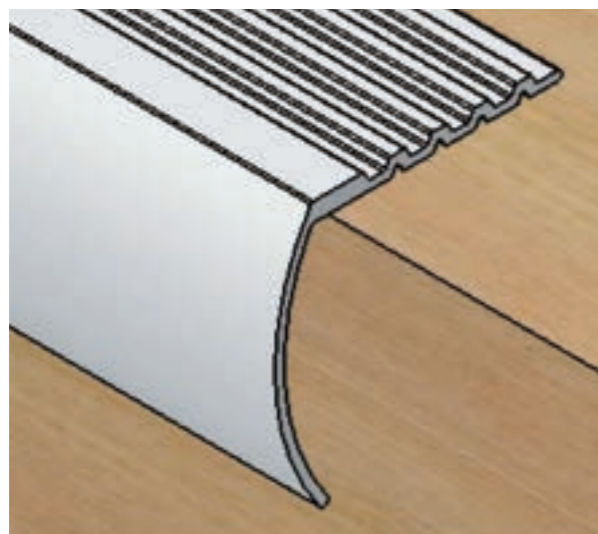
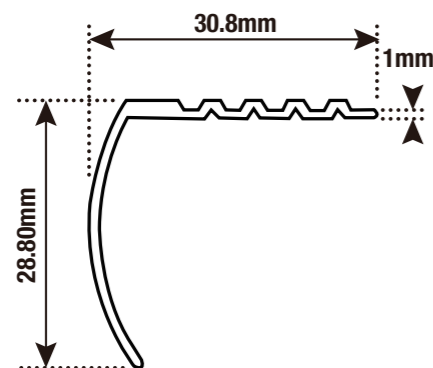

3.3m LONG		28.8mm HIGH		
Colour	Code	Barcode	Pk Qty	
	Matt Silver	ASN50NMS	9314942689850	10
	Matt Bronze	ASN50NMB	9314942689867	10
	Pewter	ASN50NPE	9314942691105	10
	Matt Black	ASN50NMBL	9314942695660	10

Vinyl Landing Edge

- Landing edge for vinyl plank
- Available in 3mm and 6mm
- Available in Matt Silver, Matt Bronze and Matt Black
- Supplied in 3.66m lengths

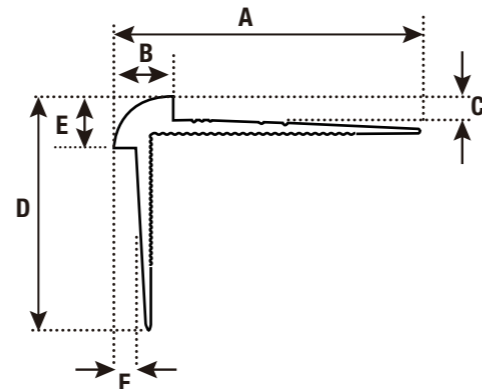

Size	A	B	C	D	E	F
	40.7mm	7.8mm	3.0mm	30.7mm	6.7mm	3.0mm
	43.5mm	7.8mm	5.8mm	33.5mm	7.8mm	5.8mm

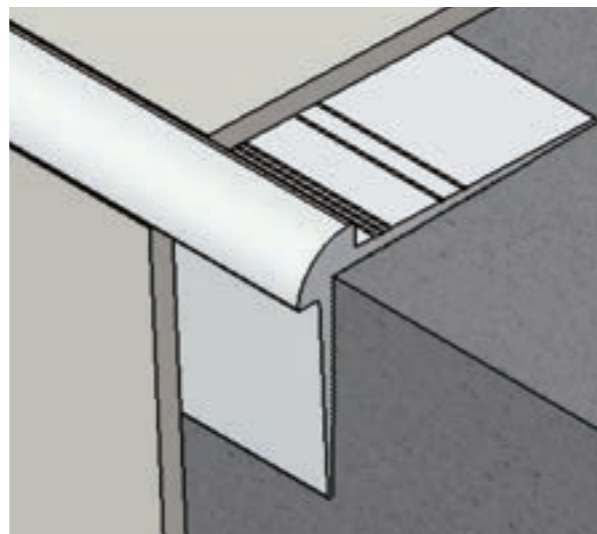

3.66m LONG		6.0 mm HIGH		
Colour	Code	Barcode	Pk Qty	
	Matt Silver	ASN30NMS	9314942689799	10
	Matt Bronze	ASN30NMB	9314942689812	10
	Matt Black	ASN30NMBL	9314942689805	10

3.66m LONG		3.0 mm HIGH		
Colour	Code	Barcode	Pk Qty	
	Matt Silver	ASN06NMS	9314942689768	10
	Matt Bronze	ASN06NMB	9314942689782	10
	Matt Black	ASN06NMBL	9314942689775	10

Illuminated Stair Profile

- High strength aluminium
- Anti-slip tread pattern
- Illumination strip for safety once lights have been turned off
- UV stable
- Adhesive fixing
- Available in Matt Silver
- Supplied in 1m and 3m lengths

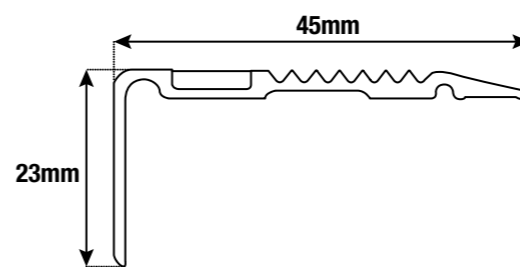

1.0m LONG		23mm HIGH		
Colour	Code	Barcode	Pk Qty	
	Matt Silver	AST1.45MSAI	9314942665908	12

3.0m LONG		23mm HIGH		
Colour	Code	Barcode	Pk Qty	
	Matt Silver	AST3.45MSAI	9314942667438	12

Stair Edge Profile

- Perfect for the protection of stairs
- 50mm tread to protect the carpet, vinyl, timber or tile edges
- Screw and plug fixing
- Available in Plain finish
- Supplied in 1m lengths

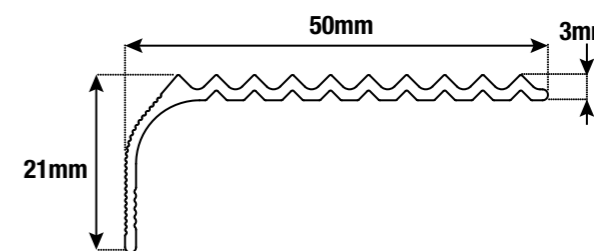

1.0m LONG		50mm WIDE		
Colour	Code	Barcode	Pk Qty	
	Plain	ASTR50.1PL	9314942662631	12

Commercial Aluminium Stair Tread

TRADE

- Utilises high strength, heat treated aluminium alloy for extra durability
- Heavy duty design with anti slip tread for commercial stairways
- Suitable for both indoor and outdoor applications
- UV and water resistant
- Tested to the requirements of AS4586:2013 with a P5 slip resistance rating
- Available in Matt Silver finish
- Supplied in 1m and 3m lengths

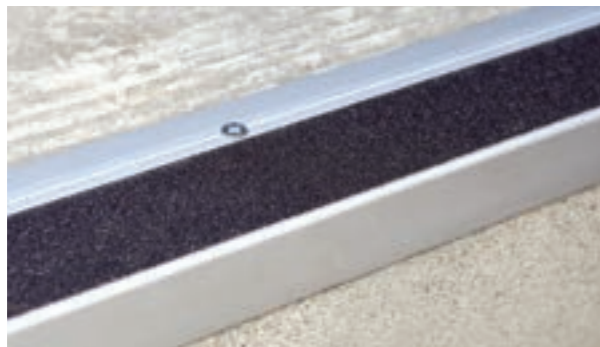
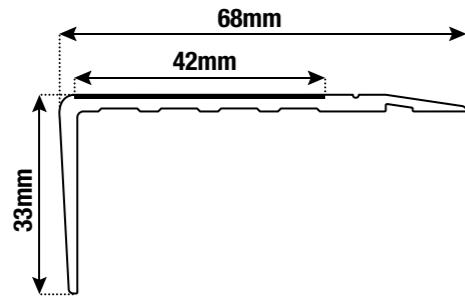

ALLOY: 6063 TEMPER: T5

MECHANICAL PROPERTY					
STANDARD	DIMENSION (mm)	0.2% Proof Stress minimum (N/mm ²)	Tensile Strength minimum (N/mm ²)	Elongation (%)	Elongation on 50mm (%)
(DIN/BS) EN 573-3:1994	<=3	130	175	8	6
(DIN/BS) EN 755-2:1997	3<e<=25	110	160	7	5

1m LONG		68mm WIDE			
Colour	Size	Code	Barcode	Pk Qty	
Matt Silver	1m x 68mm	AST1.68MS	9314942660507	12	
Matt Silver	1m x 68mm WITH ADHESIVE	AST1.68MSA	9314942661573	12	

3m LONG		68mm WIDE			
Colour	Size	Code	Barcode	Pk Qty	
Matt Silver	3m x 68mm	AST3.68MS	9314942660118	12	

Commercial Aluminium Stair Tread with Illumination

TRADE

- Utilises high strength, heat treated aluminium alloy for extra durability
- Heavy duty design with anti slip tread for commercial stairways
- The illuminated strip allows for illumination of the trim when lights have been turned off
- Self adhesive for easy installation
- 30 minutes in the light allows for 7 hours of illumination
- Suitable for both indoor and outdoor applications
- UV and water resistant
- Complies with Safety Standard AS/NZ 4586
- Available in Matt Silver finish
- Supplied in 1m and 3m lengths

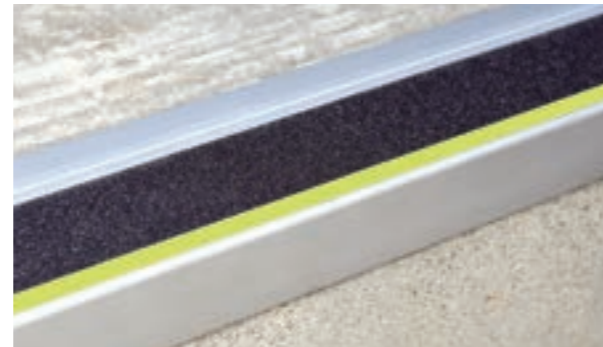
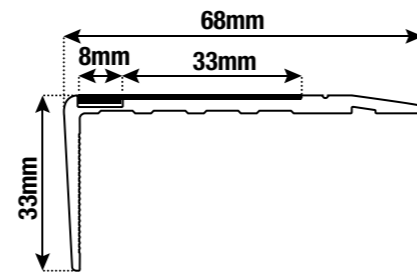

ALLOY: 6063 TEMPER: T5

MECHANICAL PROPERTY					
STANDARD	DIMENSION (mm)	0.2% Proof Stress minimum (N/mm ²)	Tensile Strength minimum (N/mm ²)	Elongation (%)	Elongation on 50mm (%)
(DIN/BS) EN 573-3:1994	<=3	130	175	8	6
(DIN/BS) EN 755-2:1997	3<e<=25	110	160	7	5

1m LONG		68mm WIDE			
Colour	Size	Code	Barcode	Pk Qty	
Matt Silver	1m x 68mm	AST1.68MSAI	9314942663096	12	

3m LONG		68mm WIDE			
Colour	Size	Code	Barcode	Pk Qty	
Matt Silver	3m x 68mm	AST3.68MSAI	9314942663102	12	

Fibreglass Flatbar Stair Nosing

TRADE

- Industrial fibreglass reinforced Stair nosing is suitable for high traffic access areas
- Heavy duty grit provides a non-slip surface even in wet, oily, greasy or dusty environments
- Waterproof and UV resistant
- We recommend installation with mechanical and adhesive fixings (Fixings and screw holes not included)
- Available in Yellow finish
- Supplied in 1.2m lengths
- Compliance**
- Profile designed to comply with AS1428.1-2021
- Tested to the requirements of AS4586:2013 with a P5 Slip Resistance rating

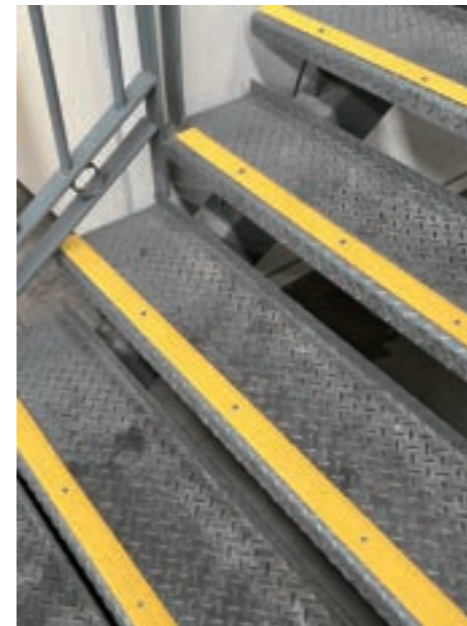
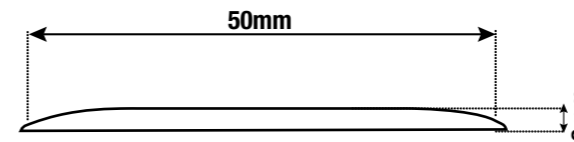

1.2m LONG		3mm HIGH			
Colour	Code	Barcode	Pk Qty		
Yellow	FSE50	9314942698883	20		

Fibreglass Stairnosing

TRADE

- Industrial fibreglass reinforced Stairnosing is suitable for high traffic access areas
- Heavy duty grit provides a non-slip surface even in wet, oily, greasy or dusty environments
- Waterproof and UV resistant
- We recommend installation with mechanical and adhesive fixings (Fixings and screw holes not included)
- Available in Yellow finish
- Supplied in 1.2m lengths
- Compliance**
- Profile designed to comply with AS1428.1-2021
- Tested to the requirements of AS4586:2013 with a P5 Slip Resistance rating

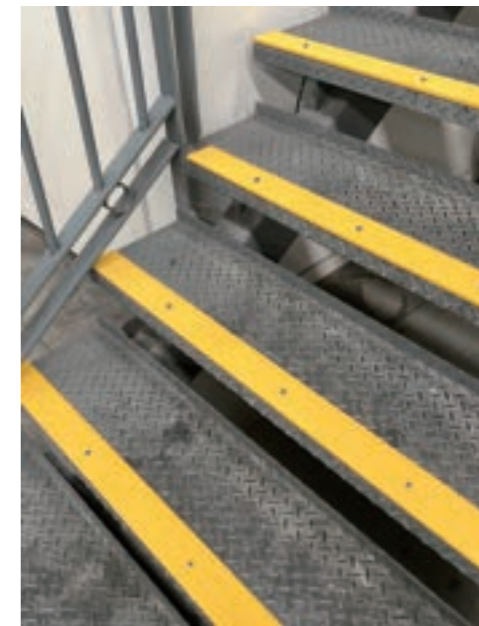
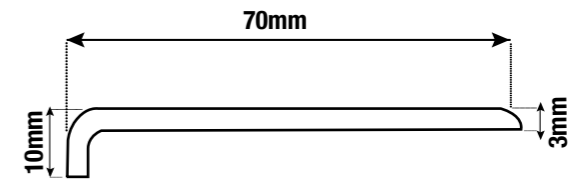

1.2m LONG		10mm HIGH			
Colour	Code	Barcode	Pk Qty		
Yellow	FSN70	9314942698890	20		

Gecko Grip Tape



- Designed to provide a safe, non-slip surface under shoe traffic to prevent unnecessary slips and falls
- Strong PET backing filled with a gritty mineral abrasive to create traction
- PET backing is stronger and more durable than those with a PVC backing
- UV Properties
- Indoor and outdoor Use
- Carbide 60 Grit
- Easily adheres to most surfaces
- Tested to slip resistance standard AS 4586:2013 with a slip resistance rating of P5



Anti Slip

Colour		Code	Width	Length	Barcode	Pk Qty
	Yellow	ASAT25X5Y	25mm	5m	9314942684022	12
	Clear	ASAT25X5C	25mm	5m	9314942684046	12
	Black	ASAT25X5B	25mm	5m	9314942684039	12
	Black	ASAT25X20B	25mm	20m	9314942692102	10
	Black	ASAT50X3B	50mm	3m	9314942684008	12
	Black&Yellow	ASAT50X3BY	50mm	3m	9314942693239	12
	Clear	ASAT50X3C	50mm	3m	9314942684015	12
	Yellow	ASAT50X3Y	50mm	3m	9314942683995	12
	Black&Luminescent	ASAT50X5GDB	50mm	5m	9314942693253	12
	Black&Yellow	ASAT50X5RBY	50mm	5m	9314942693260	12
	Black&Yellow	ASAT50X5WSBY	50mm	5m	9314942693246	12
	Black	ASAT50X20B	50mm	20m	9314942692089	10
	Black&Yellow	ASAT50X20BY	50mm	20m	9314942693277	10
	Yellow	ASAT50X20Y	50mm	20m	9314942692096	10



Reflective

Colour		Code	Width	Length	Barcode	Pk Qty
	Red&White	ASAT50X5RRW	50mm	5m	9314942693307	12
	White	ASAT50X5RW	50mm	5m	9314942693314	12
	Yellow	ASAT50X5RY	50mm	5m	9314942693321	12

Soft Textured

Colour		Code	Width	Length	Barcode	Pk Qty
	Grey	ASAT25X5TB	25mm	5m	9314942693284	12
	Black	ASAT25X5TG	25mm	5m	9314942693291	12



VINYL PROFILES

The DTA range of vinyl profiles are designed to increase installation speed and improve consistency of transitions and finishing of vinyl flooring.

Vinyl Transition Edge

- Wall tile to vinyl transition trim
- Flexible PVC trim with rubber cover strip to suit various vinyl thicknesses
- Available in White
- Supplied in 3m lengths

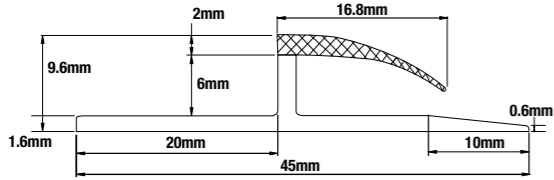

3.0m LONG | 9.6mm HIGH

Colour	Size	Code	Barcode	Pk Qty
White	8 x 16 x 45mm	VTRANS3.45W	9314942684909	20

2 Part Expansion

- Aluminium 2-piece expansion joint
- Countersunk holes at 300mm spacing
- Designed for use with 3mm commercial vinyl
- Screws and plugs included
- Stainless steel screws and plugs included
- Available in Matt Silver finish
- Supplied in 3.66m lengths

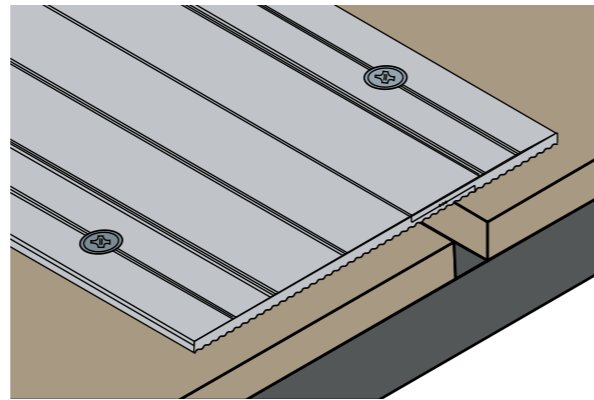
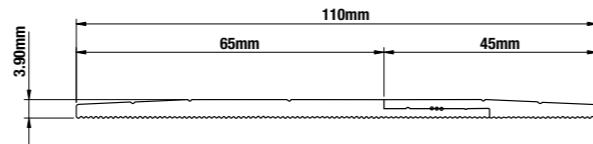

3.66m LONG | 3.9mm HIGH

Colour	Size	Barcode	Code	Pk Qty
Matt Silver	110 x 3.9mm	AEX36.110MS	9314942686163	10

Aluminium Vinyl Ramps

- Aluminium ramps for transitioning vinyl and commercial carpet tiles to timber, tile or carpet
- Quick and easy to install
- Consistent finish
- Available in Matt Silver and Matt Black
- Supplied in 3.3m lengths

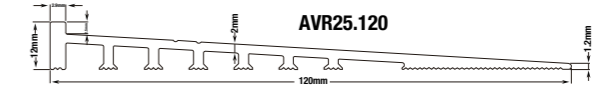
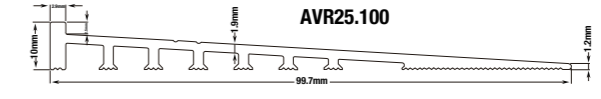
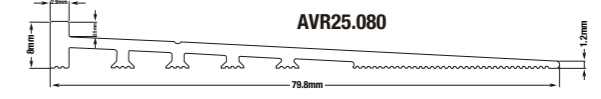
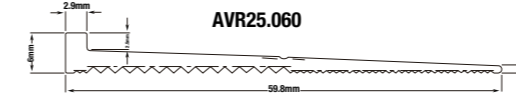
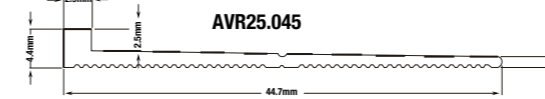
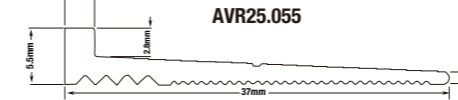

3.3m LONG | 2.5mm HIGH

Colour	Size	Code	Barcode	Pk Qty
Matt Silver	5.5mm x 2.8mm x 37mm	AVR25.055	9314942678359	10
Matt Black	5.5mm x 2.8mm x 37mm	AVR25.055NMBL	9314942697879	10
Matt Silver	4.4mm x 2.5mm x 45mm	AVR25.045	9314942678694	10
Matt Black	4.4mm x 2.5mm x 45mm	AVR25.045NMBL	9314942697862	10
Matt Silver	6mm x 2.5mm x 60mm	AVR25.060	9314942678700	10
Matt Black	6mm x 2.5mm x 60mm	AVR25.060NMBL	9314942697886	10
Matt Silver	8mm x 2.5mm x 80mm	AVR25.080	9314942678717	10
Matt Silver	10mm x 2.5mm x 100mm	AVR25.100	9314942678724	10
Matt Silver	12mm x 2.5mm x 120mm	AVR25.120	9314942678809	10

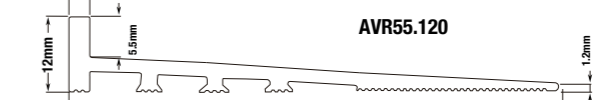
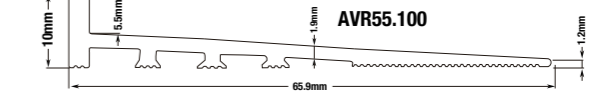
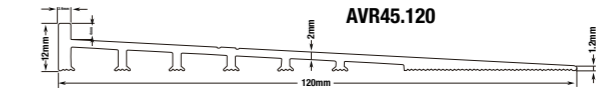
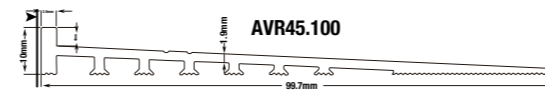
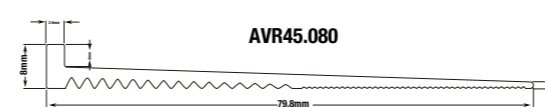

3.3m LONG | 4.5mm HIGH

Colour	Size	Code	Barcode	Pk Qty
Matt Silver	8mm x 4.5mm x 80mm	AVR45.080	9314942678748	10
Matt Silver	10mm x 4.5mm x 100mm	AVR45.100	9314942678755	10
Matt Silver	12mm x 4.5mm x 120mm	AVR45.120	9314942679363	10

3.3m LONG | 5.5mm HIGH

Colour	Size	Code	Barcode	Pk Qty
Matt Silver	10mm x 5.5mm x 65mm	AVR55.100	9314942687054	10
Matt Silver	12mm x 5.5mm x 110mm	AVR55.120	9314942689034	10

Diminishing Strip

- Designed for gradual transition from vinyl and carpet tile to the substrate
- Mill finish
- Supplied in 3.66m lengths

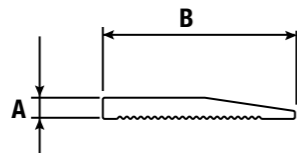

Size A	B
2mm	30mm
3mm	30mm
5mm	45mm



3.66m LONG

Colour	Size	Barcode	Code	Pk Qty
Mill Finish	2mm	ADS60	9314942691624	10
Mill Finish	3mm	ADS61	9314942691631	10
Mill Finish	5mm	ADS68	9314942691617	10

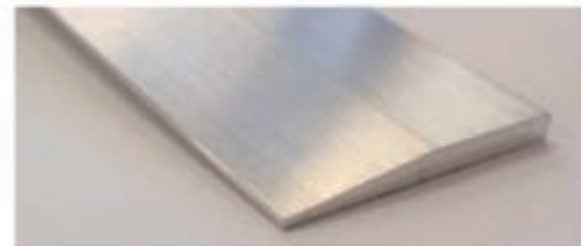

Aluminium Vinyl Ramp Expansion



- Aluminium ramps for transitioning vinyl commercial carpet tiles where an expansion joint is required
- Quick and easy to install
- Consistent finish
- Reduces down time due to drying
- Polyurethane expansion
- No more vinyl welding
- Supplied in 3.3m lengths

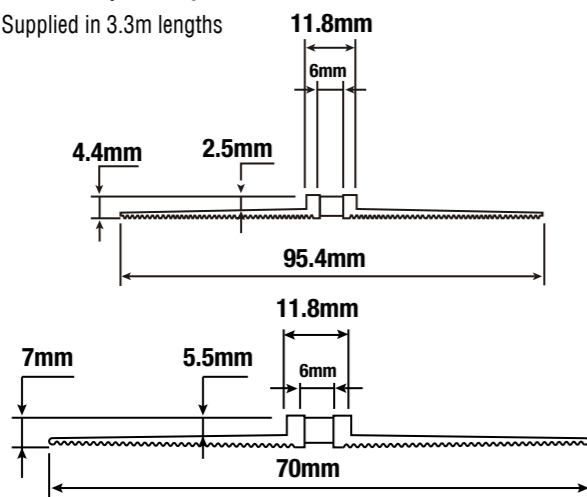

3.3m LONG 2.5mm HIGH

Colour	Size	Code	Barcode	Pk Qty
	Matt Silver - Grey Infill 4.4mm x 2.5mm x 45mm	AVREX25.045G	9314942685630	10
	Matt Black - Black Infill 4.4mm x 2.5mm x 45mm	AVREX25.045NMBL	9314942701224	10

3.3m LONG 5.5mm HIGH

Colour	Size	Code	Barcode	Pk Qty
	Grey 7mm x 5.5mm x 45mm	AVREX55.070G	9314942691938	10

2mm Vinyl Transition Aluminium



- Suitable for 2mm vinyl
- 1 in 4 ramp gradient
- Available in Matt Silver, Matt Black, Matt Champagne and Matt Bronze
- Supplied in 3.3m lengths

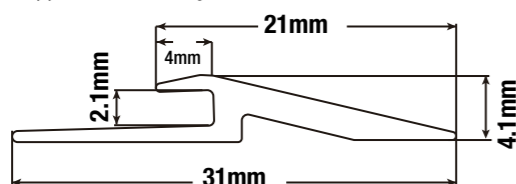

3.3m LONG 2.1mm HIGH

Colour	Size	Code	Barcode	Pk Qty
	Matt Silver 4.1mm x 2.1mm x 31mm	VTR33.020NMS	9314942695622	10
	Matt Black 4.1mm x 2.1mm x 31mm	VTR33.020NMBL	9314942695639	10
	Matt Champagne 4.1mm x 2.1mm x 31mm	VTR33.020NMC	9314942695646	10
	Matt Bronze 4.1mm x 2.1mm x 31mm	VTR33.020NMB	9314942695653	10

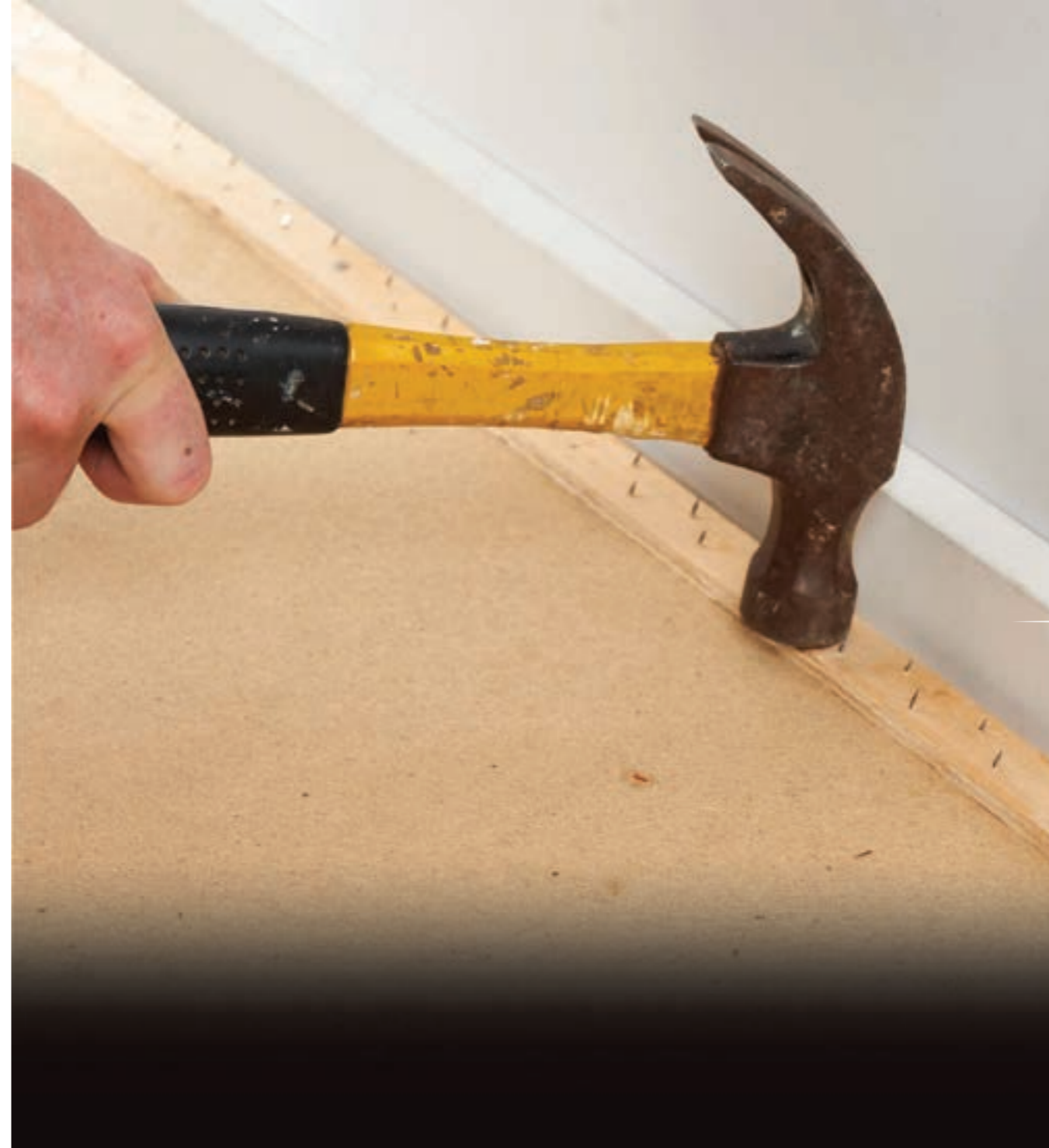

FLOOR ACCESSORIES

DTA also offers a range of floor installation accessories including tactile indicators, carpet heat seam tape, screws and nails to finalise the installation process and perfect your flooring.

Stainless Steel Screws

- Stair nosing stainless steel screws and plugs
- #8 gauge stainless steel screw
M4.1 x 38 and 6mm plug
- 100 screws and plugs per pack
- Suits the ASN range of stair nosing as follows
ASN51, ASN52, ASN56, ASN58, ASN75, ASN111,
ASN150, ASN151, ASN153, ASN154, ASN155



Code	Barcode	Pk Qty
ASNSS100	9314942692300	100

Nails for Gripper Strip

- Ideal for carpet gripper
- Heavy Duty Concrete Nails
- 16mm x 3.3mm
- 1kg pack

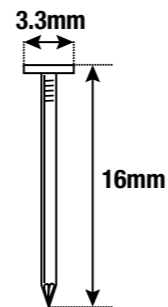

Code	Barcode	Pk Qty
CGNC1.16	9314942665069	12

Carpet Heat Seam Tape

- The knitted backing pad will not stick to the underlay
- It has fibreglass reinforcement giving it a stronger bonding
- Available in 20 metre rolls in two widths
88mm and 105mm

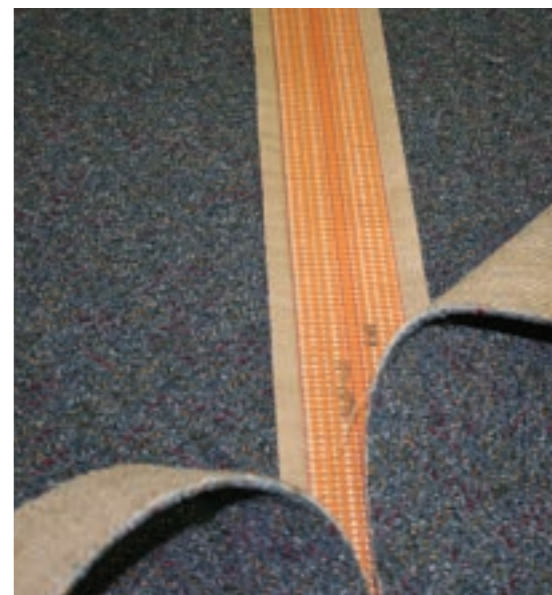

Code	Barcode	Size	Pk Qty
CHST20.88	9314942665106	88mm x 20m	1
CHST20.105	9314942665120	105mm x 20m	1



Tactile Indicators

- 300mm x 300mm x 8mm
- 3 pack
- 2 designs: stud pattern and directional pattern
- 3 colours: black, grey and yellow
- Rubber EPDM material
- Suitable for internal and external applications
- UV resistant
- AS/NZS 1428.4.1
- Slip rated (stud pattern): P4 Slip Rating
- Slip rated (directional pattern): P5 Slip Rating



Colour	Size	Code	Barcode	Pk Qty
Black Directional	300mm x 300mm	TD300B	9314942698937	3
Grey Directional	300mm x 300mm	TD300G	9314942689034	3
Yellow Directional	300mm x 300mm	TD300Y	9314942698944	3
Black Stud	300mm x 300mm	TI300B	9314942698906	3
Grey Stud	300mm x 300mm	TI300G	9314942698920	3
Yellow Stud	300mm x 300mm	TI300Y	9314942698913	3