



www.dtaigroup.com
The Choice of Professionals



Tiling Tools & Accessories

Catalogue Edition 9

AUSTRALIA

Head Office - VICTORIA

ABN 26 007 291 054

P 1800 505 045

E sales@dta-aus.com.au

P.O. Box 318, Patterson Lakes 3197

6 Ashley Park Drive, Chelsea Heights 3196



NEW SOUTH WALES

P 1800 505 045

E sales@dta-aus.com.au

Unit 1/56-58 Jedda Rd, Prestons 2170

WESTERN AUSTRALIA

P 1800 505 045

E dtawa@dta_au.com.au

Unit 2/12 Horus Bend, Bibra Lake 6163

QUEENSLAND

P 1800 505 045

E dtaqld@dta-aus.com.au

7 Hinkler Court, Brendale 4500

SOUTH AUSTRALIA

P 1800 505 045

E sales@dta-aus.com.au

NEW ZEALAND

P 09 525 0321

E sales@dtanz.co.nz

2/27 Cain Rd Penrose, Auckland 1061

USA

P +1 925 371 7101

E sales@dtausagroup.com

DTA USA Group Inc. 2612 Station Drive
 Stockton, CA, USA 95215

DTA reserve the right to change product specifications without notice. Products may vary from pictures shown.
 Colours shown are as close as possible to actual colours.



The Choice of Professionals



The Choice of Professionals

DTA Tiling Tools are designed and manufactured for use by tiling professionals and handypersons. They cover a wide range of indispensable products that make tiling both easier and more profitable. These range from trowels to spacers, silicones to grout scrubbers. For example, DTA trowels are available in various steels with a variety of notches and handles at many price points. DTA also offer general hand tools and power tools as well as handy gadgets that help make tiling easier. If you have any project that requires tiling DTA will have a tool to help you.

TILING HANDTOOLS

5

Hand Tile Cutters	6
Tile Scribes	7
Tile Saw	8
Adhesive Spreaders	9
Paint Scrapers and Spreaders	10
Adhesive Trowels	10
Wall / Floor Scrapers	16

GENERAL HANDTOOLS

18

General Handtools and Accessories	19
Knee Pads	21
Suction Cups	22
BOSS Pro Levels	23
Straight Edges	23
Contour Gauges	23

LIPPAGE SYSTEMS & TILE SPACERS

24

Y-Shape Tile Spacers	25
Deep Tile Spacers	25
Cross Tile Spacers	25
T-Shape Tile Spacers	28
Wedges	29
Lippage Cap System	30
Livello Levelling System	31
Wedge Levling System	32
Flatout Levelling System	33
Mosaic Spacers	34

INDEX



GROUTING & CLEAN-UP

35

Glue and Paint Mixers	36
Mixing Paddles	37
Grouters	38
Rubber Trowels	38
Clean-up Systems	39
Sponges	40
Scouring Pads and Replacements	42
Grout Joint Removers	43

CLEANERS & PROTECTORS

44

Tile Sealers and Cleaners	45
Silicone Tools and Accessories	46
Enduro Shield DIY Kit	46
Paint Roller And Tray	47
Caulking Guns	47
Protection Film	49
Dustshied System	50

FLOOR TOOLS

52

Vinyl Tools	53
Timber / Laminate Tools	54
Carpet Tools	55

MERCHANDISING

58

INDEX



TILING HANDTOOLS

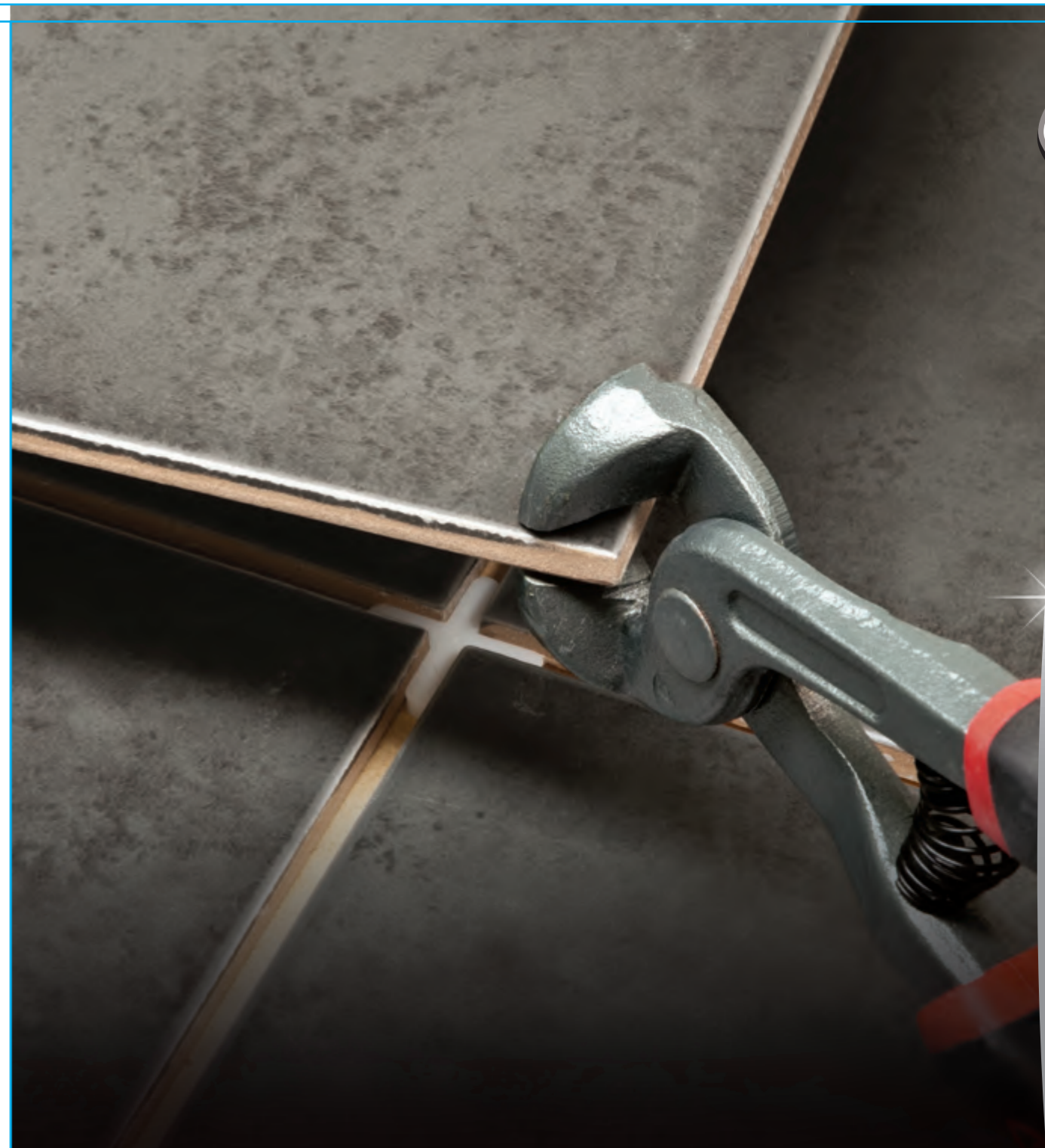

TILING HANDTOOLS

DTA hand tools range from trowels to tile nippers and everything in between. DTA trowels offer tilers a choice of handles and blades to accommodate the most complex of tiling tasks. The range has specialist tools, alongside indispensable items that are needed on every project.

Curved Jaw Hand Tile Cutter - Straight

Code: 09-011

Barcode: 9314942090113

Pk Qty: 6

- Curved jaw nipper
- Hardened tungsten carbide jaws
- Cuts small curved sections in tiles

Jaw view



Straight Jaw Hand Tile Cutter - Offset

Code: 09-012

Barcode: 9314942090120

Pk Qty: 6

- Straight jaw nipper
- Hardened tungsten carbide jaws
- Cuts small straight sections in tiles

Jaw view



Combination Straight and Curved Jaw Hand Tile Cutter

Code: 09-013

Barcode: 9314942090182

Pk Qty: 6

- Curved/Straight jaw nipper
- Tungsten carbide tipped jaws
- Spring loaded handle

Jaw view



Straight Jaw Hand Tile Cutter - Straight

Code: 09-014

Barcode: 9314942656593

Pk Qty: 6

- Straight jaw nipper
- Tungsten carbide tipped jaws
- Spring loaded handle

Jaw view



Trade GT Straight Jaw Tile Nipper

Code: 09-268

Barcode: 9314942092681

Pk Qty: 6

- Straight jaw nipper
- Tungsten carbide tipped jaws
- Comfortable ergonomic design

Jaw view



Parrot Beak Nipper

Code: 09-204

Barcode: 9314942092049

Pk Qty: 6

- Parrot beaked jaw nipper
- Tungsten carbide tipped jaws
- Cuts larger holes from the middle of tiles

Jaw view



Rotary Hand Tile Cutter

Code: 09-134

Barcode: 9314942091349

Pk Qty: 6

- Lightweight hand tile cutter
- Tungsten carbide scoring wheel
- Breaker arm for tile cutting
- Ideal for ceramic wall tiles
- Perfect for small cutting jobs

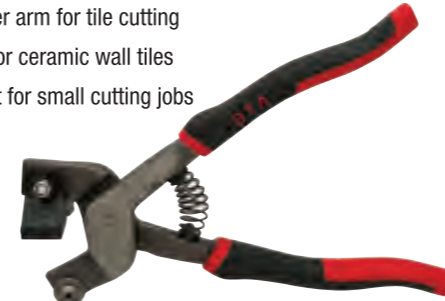

Twin Wheel Mosaic Cutter

Code: TWMC

Barcode: 9314942090144

Pk Qty: 6

- Ideal for cutting glass mosaics and tiles
- Comfortable handle



Trade Tile Scriber

Code: 09-176

Barcode: 9314942091769

Pk Qty: 12

- Tungsten carbide tipped scoring blade
- Lightweight construction
- Contoured handle for comfortable operation



Quarry Tile Nipper

Code: 09-217

Barcode: 9314942092179

Pk Qty: 6

- Extremely robust heavy-duty nipper
- Oversized tungsten carbide tipped jaws
- Lengthened handles (250mm)
- Suited to cut quarry and large tiles



White Rubber Mallet 600g (1.2lb)

Code: RM2W

Barcode: 9314942242420

Pk Qty: 6

- Designed to easily embed larger tiles into adhesive and screed
- White rubber protects the surface of tiles from damage and marks



DIY Tile Scriber

Code: 09-182

Barcode: 9314942091820

Pk Qty: 24

- Tungsten carbide tip for easy tile glaze scoring
- Includes a protective storage cap
- Simple to use





TILING HANDTOOLS

TILING HANDTOOLS

Diamond Tile Scriber / Grout Remover

Code: 22-291CG

Barcode: 9314942515258

Pk Qty: 12



- Tungsten carbide scoring wheel and pins for breaking tiles
- Grout remover comes with two tungsten carbide tipped blades in handle



Hacksaw Grit Edge 300mm

Code: HS12

Barcode: 9314942001119

Pk Qty: 10



- Tungsten carbide blade edge
- Ideal for straight cutting tiles
- Fits any standard hacksaw



Diamond Sand Pad

- Used for the smoothing of ceramic and porcelain tile edges
- Hard wearing synthetic diamond surface
- Comfortable foam grip



Grit	Code	Barcode	Pk Qty
600	DSP600	9314942666561	10
400	DSP400	9314942666554	10
200	DSP200	9314942659020	10
60	DSP60	9314942659013	10

Tile Saw 150mm

Code: 1115

Barcode: 9314942011156

Pk Qty: 12



- Designed to accommodate 6" rod saws
 - Steel frame construction
 - Comfortable contoured rubber handle
 - Cuts different shapes and holes in tiles
 - Complete with blade
 - Includes coping saw and hacksaw blades
- REPLACEMENT BLADE - RS6



Rod Saw

- Tungsten carbide construction
- Easily attaches to a saw handle
- Fits any standard hacksaw
- Cuts different shapes in tiles



Size	Code	Barcode	Pk Qty
150mm	RS6	9314942011064	24
300mm	RS12	9314942011125	24



Galvanised Vinyl / Cork Spreader



- V-Notch edge design
- Durable galvanised steel construction
- Ideal for applying adhesive on floors for vinyl and cork tiles

Profile	Code	Barcode	Size	Pk Qty
2.6mm / 1.9mm & 2mm	VCS	9314942430001	150-70mm	50



Galvanised Combination Adhesive Spreader 4mm

Code: AS4C

Barcode: 9314942433002

Pk Qty: 50



- 4mm square and 4mm V-Notch edge design
- Durable galvanised steel construction



Galvanised Adhesive Spreaders



- Durable galvanised steel construction
- Ideal for small repair jobs or mosaic pieces
- Square notched edge design

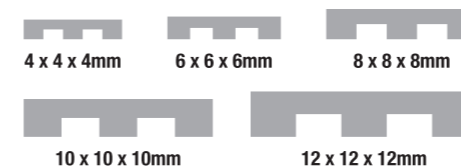

Profile	Code	Barcode	Designed for	Size	Pk Qty
4mm	AS4	9314942433040	Small Wall Tiles	145 - 95mm	50
6mm	AS6	9314942433064	Wall Tiles	140 - 95mm	50
8mm	AS8	9314942433088	Floor & Wall Tiles	150 - 95mm	50
10mm	AS10	9314942433101	Floor Tiles	150 - 95mm	50
12mm	AS12	9314942433125	Floor Tiles	140 - 95mm	50

Paint Scraper

- For cleaning excess adhesive or plaster from small surfaces before tile laying



Profile	Code	Barcode	Designed for	Size	Pk Qty
50mm	2PS	9314942020004	Small Surfaces	50mm	12
75mm	3PS	9314942030003	Small Surfaces	75mm	12
100mm	4PS	9314942040066	Small Surfaces	100mm	12

Adhesive Spreader

- Strengthened steel square notched scraping edge for wall tiles
- Comfortable plastic handle
- Ideal for applying adhesive around vanities

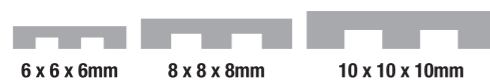

Profile	Code	Barcode	Designed for	Size	Pk Qty
6mm	4PSN	9314942040002	Wall Tiles	100mm	12
8mm	4PSN8	9314942000082	Wall & Floor Tiles	100mm	12
10mm	4PSN10	9314942040064	Floor Tiles	100mm	12

Galvanised Economy Adhesive Trowel

- Dual square notched edge design
- Comfortable plastic handle
- Lightweight and durable

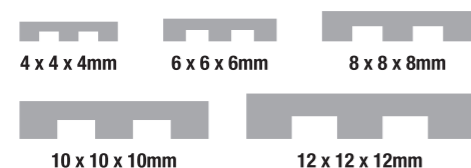

Profile	Code	Barcode	Designed for	Size	Pk Qty
4mm	EAT4	9314942434047	Small Wall Tiles	280 - 115mm	5
6mm	EAT6	9314942434061	Wall Tiles	280 - 115mm	5
8mm	EAT8	9314942434085	Wall & Floor Tiles	280 - 115mm	5
10mm	EAT10	9314942434108	Floor Tiles	280 - 115mm	5
12mm	EAT12	9314942434122	Large Format Tiles	280 - 115mm	5

Bright Steel Adhesive Trowels Renovator Series

- Dual square notched edge design
- Highest grade construction
- Stainless steel rivets
- Rubber contoured handle
- Durable yet lightweight

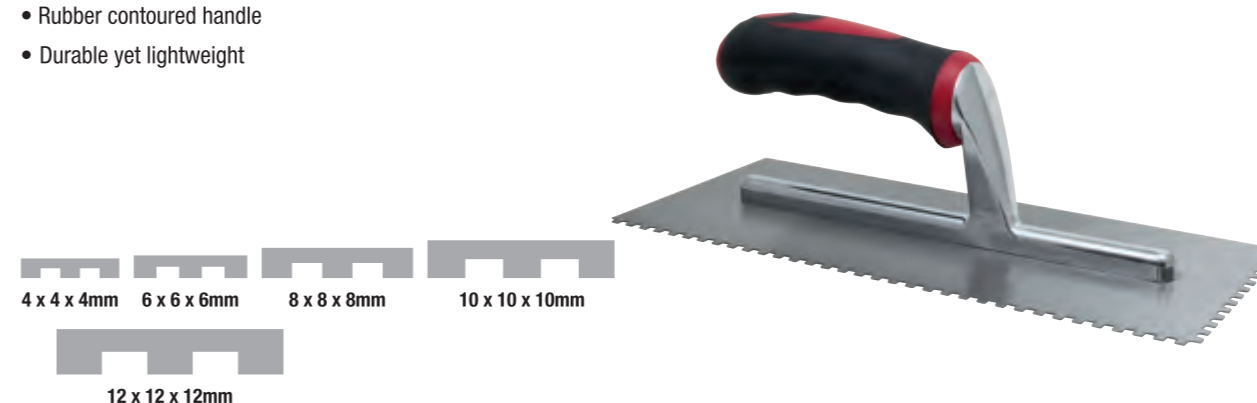

Profile	Code	Barcode	Designed for	Size	Pk Qty
4mm	BSTR4	9314942135043	Small Wall Tiles	280 - 115mm	5
6mm	BSTR6	9314942135067	Wall Tiles	280 - 115mm	5
8mm	BSTR8	9314942135081	Floor & Wall Tiles	280 - 115mm	5
10mm	BSTR10	9314942135104	Floor Tiles	280 - 115mm	5
12mm	BSTR12	9314942135128	Large Format Tiles	280 - 115mm	5
15mm	BSTR15	9314942658825	Large Format Tiles	280 - 115mm	5

Bright Steel Adhesive Trowels Trade Series

- Dual square notched edge design
- Highest grade flexible spring steel construction
- Stainless steel rivets, die cast aluminium with contoured rubber handle
- The ultimate in comfort and durability



Profile	Code	Barcode	Designed for	Size	Pk Qty
4mm	BST4	9314942123040	Small Wall Tiles	280 - 115mm	5
6mm	BST6	9314942123064	Wall Tiles	280 - 115mm	5
8mm	BST8	9314942123088	Floor & Wall Tiles	280 - 115mm	5
10mm	BST10	9314942123101	Floor Tiles	280 - 115mm	5
12mm	BST12	9314942123125	Large Format Tiles	280 - 115mm	5
15mm	BST15	9314942659785	Large Format Tiles	280 - 115mm	5
1.6mm V-Notch	BSTV16	9314942667179	Floating Wooden Floors	280 - 115mm	5
3mm V-Notch	BSTV3	9314942664628	Wooden Floors	280 - 115mm	5
4mm V-Notch	BSTV4	9314942124047	Wooden Floors	280 - 115mm	5
6mm V-Notch	BSTV6	9314942124061	Wooden Floors	280 - 115mm	5

V-Notch Bright Steel Adhesive Trowel

Code: **BSTV16-4**

Barcode: **9314942685395**

Pk Qty: **5**



- Contoured handle improves control and comfort
- Handle fastened to blade with 6 welded rivets
- 0.6mm quality stainless steel base
- 1.6mm V Notch on all four edges

Tiger Trowel

Code: **USTR**

Barcode: **9314942668374**

Pk Qty: **5**



VIDEO DEMO
 1.To view the video, download any QR Code Reader App. on your smart phone.
 2.Scan the QR Code to watch video.

- Specially designed notches providing 100% coverage
- Highest grade flexible spring steel construction
- Stainless steel rivets, die cast aluminium with contoured rubber handle

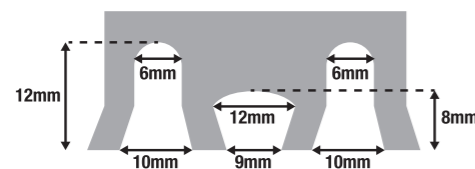

Stainless Steel Adhesive Trowels Renovator Series

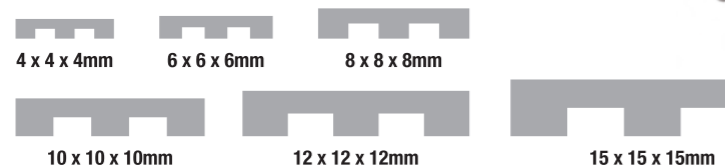

- Dual square notched edge design
- Highest grade Stainless Steel blade
- Stainless Steel rivets, die cast aluminium with contoured rubber handle
- The ultimate in comfort and durability

Profile	Code	Barcode	Designed for	Size	Pk Qty
4mm	RST04	9314942677727	Small Wall Tiles	280 - 115mm	5
6mm	RST06	9314942677734	Wall Tiles	280 - 115mm	5
8mm	RST08	9314942677741	Floor & Wall Tiles	280 - 115mm	5
10mm	RST10	9314942677758	Floor Tiles	280 - 115mm	5
12mm	RST12	9314942677765	Large Format Tiles	280 - 115mm	5
15mm	RST15	9314942688556	Large Format Tiles	280 - 115mm	5

Quik Switch Square Notch Blades

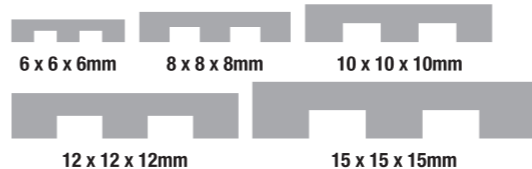

- Dual square notched edge design
- Use with Quik Switch Handle (QSTH)
- Ideal for applying adhesive
- Easier to store than traditional trowels
- Handle not included

Profile	Code	Barcode	Designed for	Size	Pk Qty
6mm	QST06	9314942684442	Floor & Wall Tiles	280 - 115mm	10
8mm	QST08	9314942684459	Floor & Wall Tiles	280 - 115mm	10
10mm	QST10	9314942684466	Floor & Wall Tiles	280 - 115mm	10
12mm	QST12	9314942684473	Floor & Wall Tiles	280 - 115mm	10
15mm	QST15	9314942684480	Floor & Wall Tiles	280 - 115mm	10

Quik Switch V-Notch Blades

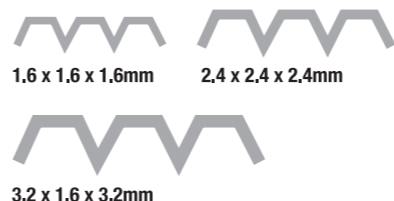

- 4 sided V-Notch edge design
- Use with Quik Switch Handle (QSTH)
- Ideal for applying adhesive
- Easier to store than traditional trowels
- Handle not included

Profile	Code	Barcode	Designed for	Size	Pk Qty
1.6mm	QSTV1	9314942684411	Vinyl	290 - 110mm	10
2.4mm	QSTV2	9314942684428	Carpet	290 - 110mm	10
3.2 x 1.6 x 3.2mm	QSTV3	9314942684435	Outdoor carpet / Grass	290 - 110mm	10

Quik Switch Plastering Trowel



Code: **QSTPT**
 Barcode: **9314942686040**
 Pk Qty: **10**

- Use with Quik Switch Handle (QSTH)
- Ideal for applying adhesive, plaster or render
- Easier to store than traditional trowels
- Handle not included

Quik Switch Grouting Trowel

Code: **QSTGT**

Barcode: **9314942687337**

Pk Qty: **12**



- Grouting float
- Use with Quik Switch Handle (QSTH)
- Ideal for applying grout
- Easier to store than traditional trowels
- Handle not included

Quik Switch Handle

Code: **QSTH**

Barcode: **9314942684404**

Pk Qty: **10**



- TPR handle for comfort
- Suitable for Quik Switch blades
- Heavy duty cast aluminium
- Adjustable handle placement

Quik Switch Storage Box

Code: **QSTB**

Barcode: **9314942684664**

Pk Qty: **10**



- Designed for storing of Quik Switch Trowel Blades and Handle

Quik Switch Trowel Kit

Code: **QSTK**

Barcode: **9314942685784**

Pk Qty: **1**



- Includes:
 - 6mm Square-Notch Trowel Blade
 - 8mm Square-Notch Trowel Blade
 - 10mm Square-Notch Trowel Blade
 - 12mm Square-Notch Trowel Blade
 - 15mm Square-Notch Trowel Blade
 - Soft Grip Handle
 - Blade Storage Box

Bright Steel Adhesive Trowels Notched - 400mm x 100mm

- Highest grade flexible spring steel blade
- Fastened with stainless steel rivets
- Ideal for plastering, cement finishing and adhesive application

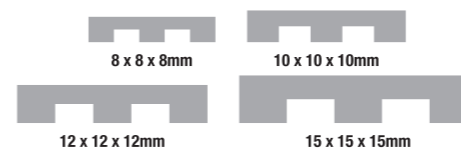

Profile	Code	Barcode	Designed for	Size	Pk Qty
8mm	BST4008	9314942655237	Large Wall Tiles	400 - 100mm	5
10mm	BST40010	9314942655244	Floor Tiles	400 - 100mm	5
12mm	BST40012	9314942655251	Large Format Tiles	400 - 100mm	5
15mm	BST40015	9314942655220	Large Format Tiles	400 - 100mm	5

Plastering Trowel - Deluxe

Code: **P037**

Barcode: **9314942123118**

Pk Qty: **5**



- Plastering trowel for applying plaster or adhesive
 - Hardened spring steel construction
 - Durable die cast aluminium with contoured rubber handle
- DIMENSIONS - 280mm(L) x 115mm(W)

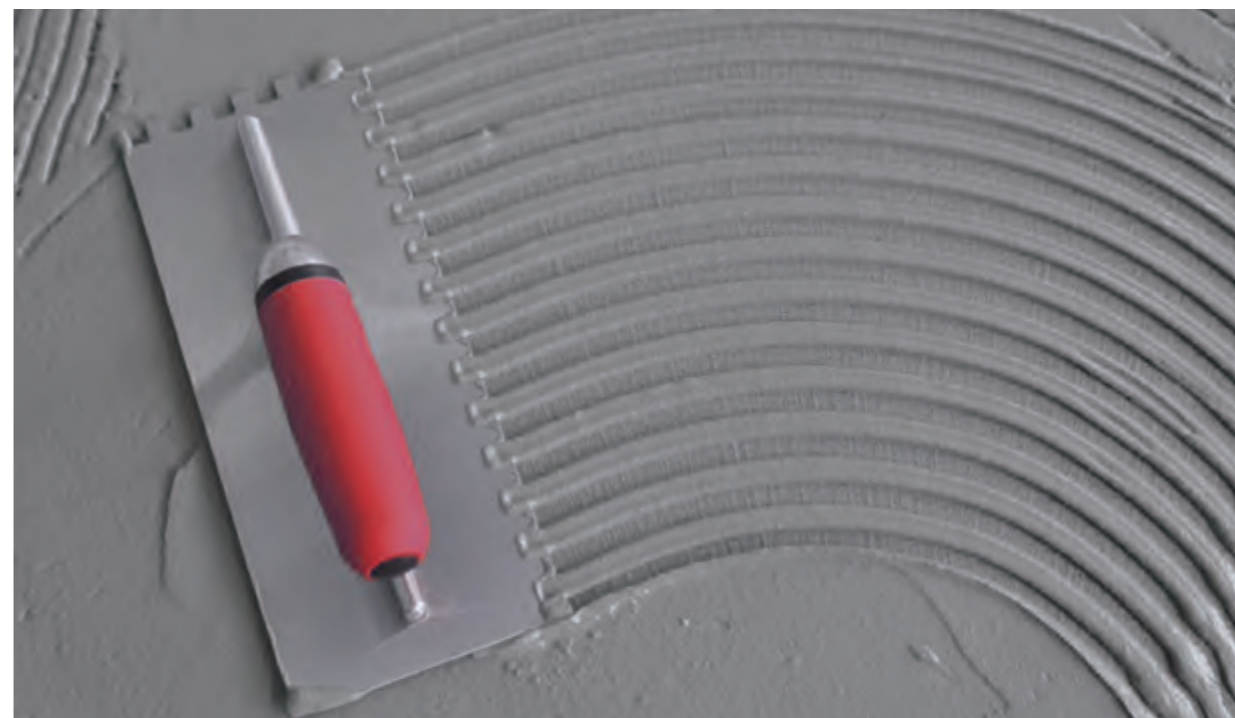

Gauging Trowels

- Used for applying adhesive
- Hardened spring steel construction
- Comfortable contoured rubber handle



Profile	Code	Barcode	Designed for	Pk Qty
180mm	GT017	9314942000174	Small Wall Tiles	12
200mm	GT018	9314942000181	Wall Tiles	12

Margin Trowel

Code: 004

Barcode: 9314942226055

Pk Qty: 12



- 100mm margin trowel for applying adhesive to the back of tiles
 - Hardened steel construction with contoured wooden handle
- DIMENSIONS - 100mm



Splash Trowel

- Splash trowel for mixing and applying adhesive
- Hardened spring steel construction
- Comfortable contoured rubber handle



Size	Code	Barcode	Pk Qty
140mm	ST140	9314942655510	5
200mm	ST200	9314942002000	5

100mm Deluxe Wall Scraper

Code: 4DWS

Barcode: 9314942440048

Pk Qty: 12



- Ideal for removing tiles from wall displays, showers and splashbacks
- Rubber contoured handle with steel cap for extra strength
- Steel blade 1.2mm thick, bent for extra leverage



165mm Bucket Scoop

Code: DTABS

Barcode: 9314942695356

Pk Qty: 12



- Stainless Steel
- Ideal for Tile Adhesive, Grout and Render



125mm Heavy Duty Wall / Floor Scraper

- Removes wallpaper, paint, small amounts of grout, adhesive and plaster from concrete floors
- Designed for wall and floor tiles
- Steel construction



Product	Code	Barcode	Pk Qty
Scraper	5WFS	9314942656586	6
Replacement Blade	5WFSB	9314942656609	10



Floor Scraper

- Heavy-duty construction
- Effectively cleans excess plaster and adhesive from cement before tile laying



Size	Product	Code	Barcode	Pk Qty
150mm	Scraper	FS150	9314942000990	6
150mm	Replacement Blade	FS150RB	9314942320326	6
200mm	Scraper	FSHD200	9314942200000	6
200mm	Replacement Blade	FSHD200RB	9314942322245	6
300mm	Scraper	FSHD300	9314942330332	6
300mm	Replacement Blade	FSHD300RB	9314942321231	6





GENERAL HANDTOOLS

DTA offer general hand tools and power tools as well as handy gadgets that help make tiling easier. The range has specialist tools, alongside indispensable items that are needed on every project.

Angle Grinder

Code: **CAG720BP**

Barcode: **9314942681717**

Pk Qty: **1**



- 105mm Angle Grinder
- 720Watt
- 230V/50Hz
- 11, 000 RPM
- M10 Thread
- 16mm Flange
- Quick release guard
- 2 x 105mm Cyclone Mesh Blades included



GEL PRO Tradesman Gloves

Code: **BTGL**

Barcode: **9314942678793**

Pk Qty: **10**



- All purpose gloves
- Durable and hard wearing
- Padded palm grip for extra comfort
- Adjustable velcro wrist strap



Tile Levelling Support - Single

Code: **DTATS**

Barcode: **9314942659983**

Pk Qty: **8**



- Adjustable tile levelling support
- Trigger adjustment for accurate levelling
- Quick release button
- To be used with straight edge
- Adjustable from 115mm - 310mm



Bucket Dolly with Wheels

Code: **BDOLLY**

Barcode: **9314942682349**

Pk Qty: **1**



- 5 castor wheels
- 3 castor wheels with brake
- Suitable for 20L buckets
- Durable plastic construction
- Ideal for moving adhesive around site





DTA Pencils - 6 Pack

Code: **DTAPENCIL**

Barcode: **9314942659297**

Pk Qty: **100**



- Ideal for marking concrete, timber and tiles for cutting



DTA Tile Marker Pens

Code: **DTAMARK**

Barcode: **9314942662075**

Pk Qty: **12**



- White wax marker for dark tiles
- Black wax marker for light tiles
- Can be used on polished shiny surfaces



Woollen Applicator with Handle

- Highest grade merino wool applicator
- Durable timber handle and base
- Ideal for cleaning up excess grout and applying tile sealers



Product	Code	Barcode	Pk Qty
Applicator with handle	WAH	9314942923916	10



Hand Support for Tiling

Code: **HNDSPT**

Barcode: **9314942683070**

Pk Qty: **10**



- Ideal for support while applying adhesive
- Soft TPR handle
- Rubber feet for extra grip



Cement Sheet Cutter

Code: **CSC**

Barcode: **9314942199014**

Pk Qty: **10**



- Heavy-duty steel construction
- Comfortable dual rubber grips
- Ideal for cutting cement sheet for tile underlay



Silicone Remover

Code: **DTASR**

Barcode: **9314942217671**

Pk Qty: **12**



- Dual action silicone remover allowing push or pull action
- Right angle blade for easy removal of silicone, acrylic and adhesive
- Rubber contoured handle



Professional Knee Pads

- Non-marking bicast leather cover
- Premium grade neoprene
- Single velcro front fastening strap
- Comfortable design



Product	Code	Barcode	Pk Qty
Knee Pads	BPKP-XL	9314942682097	4
Knee Pads 6 pack	BPKP-XL6	9314942687580	6



Rubber Knee Pad - Economy

Code: **RKP**

Barcode: **9314942213000**

Pk Qty: **6**



- Hard wearing, one size fits all, waterproof knee pad
- Touch tape fastening and accurately knee shaped



Deluxe Hard Shell Knee Pad

Code: **KPD**

Barcode: **9314942657743**

Pk Qty: **6**



- Hard anti-roll outer shell
- Designed for extra stability
- Velcro straps - for easy adjustments



BOSS Defender Knee Pads

Code: **BDKP**

Barcode: **9314942693871**

Pk Qty: **6**



- Provides strength, comfort and adjustability
- Durable TRP and PP outer shell
- Neoprene inner lining and lower strap with velcro
- Adjustable elastic top strap for a secure fit



Precision Ultra Knee Pads (USA)

- Hard wearing rubber outer with soft foam insert
- Contoured for maximum comfort



Product	Code	Barcode	Pk Qty
Knee Pads	PKN1	735883200109	6
4 x Spare Straps	PKN1S	9314942746546	6
8 x Spare Buttons	PKN1SB	9314942786542	6
2 x Spare Padded Inserts	PKN1I	9314942726548	6



Tool Bag

Code: **TOOLBAG20**

Pk Qty: **10**



- Tool bag ideal for carrying around tiling tools
- 10 pockets outside bag
- 11 pockets inside bag



Vacuum Suction Cup

Code: **DTATSC200**

Barcode: **9314942694663**

Pk Qty: **10**



- 200mm vacuum suction
- Ideal for textured surfaces
- Pump Action with Quick Release Lever
- 100kg / 200lbs Porcelain or Stone Tile and Glass



200mm SUCTION CUP WITH GAUGE

Code: **DTASCG200**

Barcode: **9314942695165**

Pk Qty: **10**



- 120kg lifting capacity
- Includes pressure gauge
- Pump action
- Quick release lever
- Ideal for large porcelain, stone, tiles and glass



Vacuum Suction Cup

Code: **DTAVSC200**

Barcode: **9314942694656**

Pk Qty: **10**



- 200mm vacuum suction
- Pump Action
- Quick release lever
- 100kg capacity
- Ideal for large porcelain or stone tiles and glass



Aluminium Dual Suction Cup

Code: **DTASC2**

Barcode: **9314942655787**

Pk Qty: **6**



- Ideal for carrying heavy tiles such as marble, granite and large ceramic tiles
- Can be used on any clean smooth surface
- Carries up to 80kg
- Ideal for adjusting misplaced or removing cracked tiles
- Made of heavy-duty aluminium



PVC Suction Cup

Code: **DTASC**

Barcode: **9314942050803**

Pk Qty: **6**



- 30kg lift capacity, heavy-duty PVC suction cup
- Ideal for carrying marble, granite or glass tiles
- Ideal for adjusting misplaced or removing cracked tiles



Aluminium Suction Cup

Code: **DTAMSC**

Barcode: **9314942655466**

Pk Qty: **6**



- 40kg lift capacity, heavy-duty aluminium construction
- Ideal for carrying marble, granite or large ceramic tiles
- Ideal for adjusting misplaced or removing cracked tiles



Rubber Suction Cup

Code: **DTARSC**

Barcode: **9314942665854**

Pk Qty: **24**



- Heavy-duty rubber
- 80mm diameter
- 15kg lift capacity



BOSS Pro Levels

- Aluminium
- Magnified horizontal vial
- Shock absorbing bi-material end caps
- Ergo grip non-slip handles



Size	Code	Barcode	Pk Qty
600mm	LVL0600	9314942255000	10
800mm	LVL0800	9314942252054	10
1000mm	LVL1000	9314942255109	10
1200mm	LVL1200	9314942305019	10
1800mm	LVL1800	9314942302001	10



DTA Straight Edge

- Designed for accurate levelling of screed and newly laid tiles
- Durable, hard, powder coated aluminium construction



Size	Code	Barcode	Pk Qty
2400mm(L) x 25mm(W) x 75mm(H)	DTASE2400	9314942240051	4

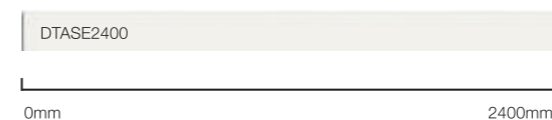

Economy Paint Brush 100mm

Code: **PB100E**

Barcode: **9314942010876**

Pk Qty: **24**



- 100mm economy paint brush
- Ideal for applying sealers and waterproofing agents



PVC Contour Gauge 250mm

Code: **PCG10**

Barcode: **9314942090168**

Pk Qty: **10**



- Durable PVC contour gauge
- Easy to use, simply press the gauge into the area to be measured
- Two gauges can be combined for extra length



Contour Profile Gauge 150mm

Code: **CPG**

Barcode: **9314942090151**

Pk Qty: **6**



- Durable steel contour gauge
- Easy to use, simply press the gauge into the area to be measured
- Ideal for doorways and around toilet bowls etc.



LIPPAGE SYSTEMS & TILE SPACERS

With DTA spacers and levelling systems, the mark of a professional tiling project is assured. DTA levelling systems are designed to remove lippage from tiles during the tiling process and are available in a range of options to suit the individual preference. DTA spacers are economical, allowing tiles to be laid uniformly project after project.



VIDEO DEMO
 1. To view the video, download any QR Code Reader App. on your smart phone.
 2. Scan the QR Code to watch video.

1.5mm Y Type Tile Spacers

- Y-Shape spacer, for 1.5mm gaps
- Ideal for wall and floor tiles
- Ideal for laying of hexagonal tiles

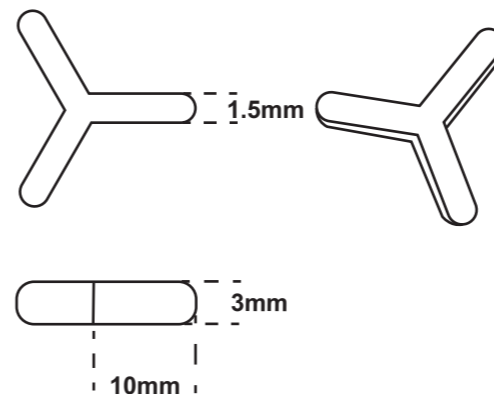

BAGS

Pieces	Code	Barcode	Pk Qty
250	YS1.5250	9314942683889	200

1.5mm Deep Tile Spacers

- Deep cross type spacer, for 1.5mm gaps
- For straight/diagonal laying of thick floor tiles

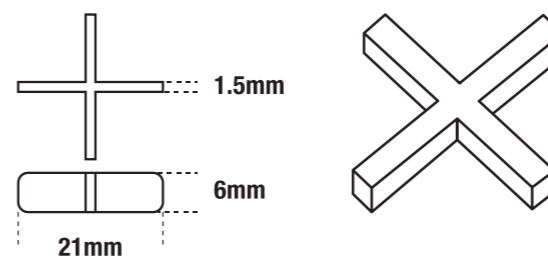

BAGS

Pieces	Code	Barcode	Pk Qty
100	DS-100	9314942401001	100
250	DS-250	9314942402503	25
500	DS-500	9314942405009	25

BUCKETS

Pieces	Code	Barcode	Pk Qty
3,000	DS-3000B	9314942658818	4
5,000	DS-5000B	9314942240556	1
8,000	DS-8000B	9314942664079	1

3mm Y Type Tile Spacers

- Y-Shape spacer, for 3mm gaps
- Ideal for wall and floor tiles
- Ideal for laying of hexagonal tiles

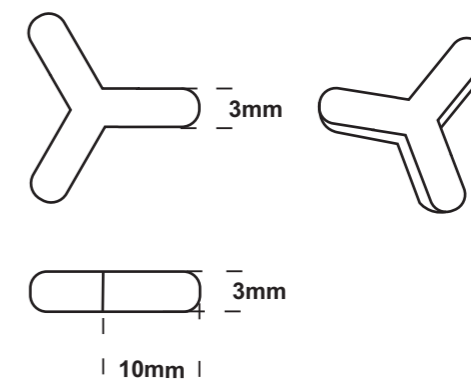

BAGS

Pieces	Code	Barcode	Pk Qty
250	YS3.0250	9314942151005	100

1mm Tile Spacers

- Cross type spacer, for 1mm gaps
- For straight/diagonal laying of smaller floor/wall tiles e.g. 200 x 200mm

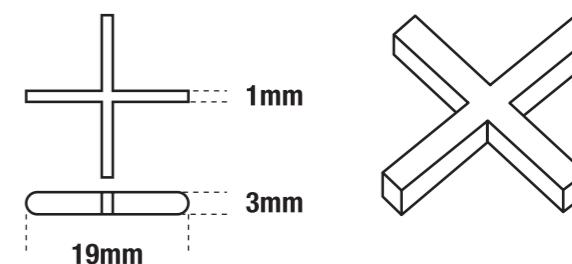

BAGS

Pieces	Code	Barcode	Pk Qty
100	1-100	9314942659808	200
500	1-500	9314942659815	60

BUCKETS

Pieces	Code	Barcode	Pk Qty
2,000	1-2000B	9314942659822	16
5,000	1-5000B	9314942659839	12

1.5mm Tile Spacers

- Cross type spacer, for 1.5mm gaps
- For straight/diagonal laying of smaller floor/wall tiles e.g. 200 x 200mm

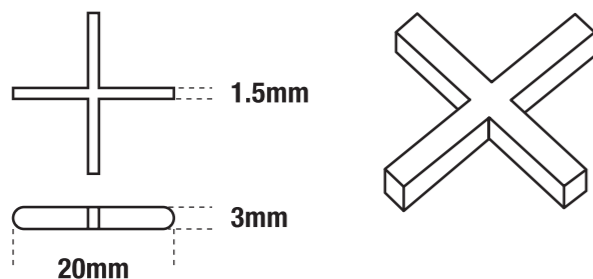

BAGS			
Pieces	Code	Barcode	Pk Qty
100	SL-100	9314942151005	200
500	SL-500	9314942155003	60
1,000	SL-1000	9314942151104	30

BUCKETS			
Pieces	Code	Barcode	Pk Qty
2,000	SL-2000B	9314942152002	6
5,000	SL-5000B	9314942155508	4
10,000	SL-10000B	9314942201007	2
25,000	SL-25000B	9314942152521	2

CARTONS			
Pieces	Code	Barcode	Pk Qty
20,000	SL-20000	9314942658757	1
50,000	SL-50000	93614942669104	1

2mm Tile Spacers

- Cross type spacer, for 2mm gaps
- For straight/diagonal laying of smaller floor/wall tiles e.g. 200 x 200mm

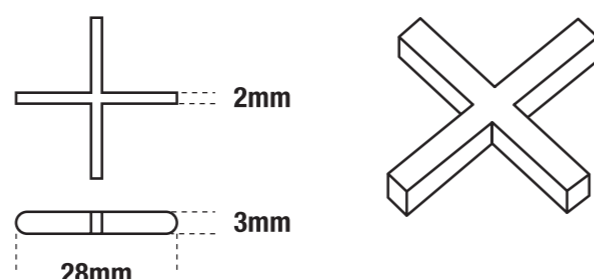

BAGS			
Pieces	Code	Barcode	Pk Qty
100	2-100	9314942659891	200
500	2-500	9314942659907	24

BUCKETS			
Pieces	Code	Barcode	Pk Qty
1,900	2-1900B	9314942659914	12
4,000	2-4000B	9314942659921	12

3mm Tile Spacers

- Cross type spacer, for 3mm gaps
- For straight/diagonal laying of smaller floor/wall tiles e.g. 300 x 300mm

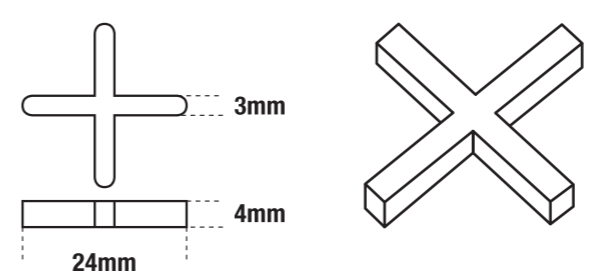

BAGS			
Pieces	Code	Barcode	Pk Qty
100	3-100	9314942301004	100
500	3-500	9314942305002	25

BUCKETS			
Pieces	Code	Barcode	Pk Qty
800	3-800B	9314942308003	6
2,000	3-2000B	9314942320005	6
5,000	3-5000B	9314942305507	4
10,000	3-10000B	9314942031000	2

CARTONS			
Pieces	Code	Barcode	Pk Qty
30,000	3-30000	9314942667582	1

5mm Tile Spacers

- Cross type spacer, for 5mm gaps
- For straight/diagonal laying of floor/wall tiles allowing more movement than 1.5mm and 3mm spacers

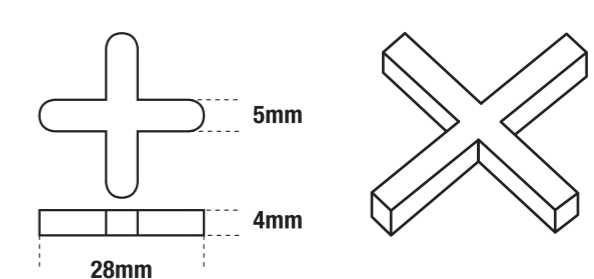

BAGS			
Pieces	Code	Barcode	Pk Qty
100	5-100	9314942501008	70
250	5-250	9314942502500	40
500	5-500	9314942505006	15

BUCKETS			
Pieces	Code	Barcode	Pk Qty
1,000	5-1000B	9314942150000	6

CARTONS			
Pieces	Code	Barcode	Pk Qty
10,000	5-10000	9314942658375	1



1.5mm T-Shape Tile Spacers

- T-Shape spacer, for 1.5mm gaps
- For brick pattern tile laying where the T-Shape allows tiles to overlap

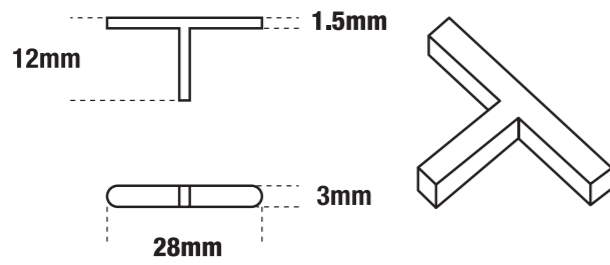

BAGS			
Pieces	Code	Barcode	Pk Qty
500	TST15-500	9314942670377	24

3mm T-Shape Tile Spacers

- T-Shape spacer, for 3mm gaps
- For brick pattern tile laying where the T-Shape allows tiles to overlap

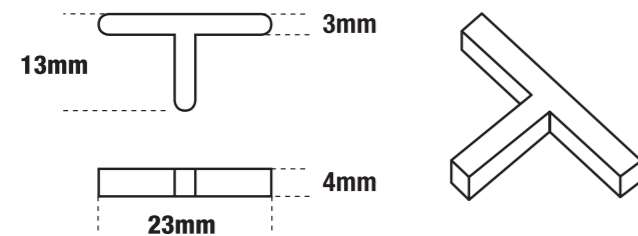

BAGS			
Pieces	Code	Barcode	Pk Qty
100	SLT3-100	9314942321002	100
500	SLT3-500	9314942325000	30

BUCKETS			
Pieces	Code	Barcode	Pk Qty
1,000	SLT3-1000	9314942662068	1

2mm T-Shape Tile Spacers

- T-Shape spacer, for 2mm gaps
- For brick pattern tile laying where the T-Shape allows tiles to overlap

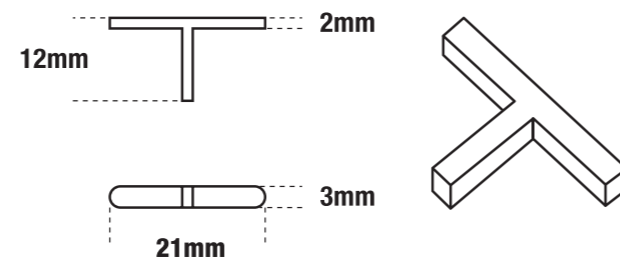

BAGS			
Pieces	Code	Barcode	Pk Qty
100	SLT-100	9314942120018	200
500	SLT-500	9314942125006	93
1,000	SLT-1000	9314942121107	30
2,000	SLT-2000	9314942157205	20

BUCKETS

Pieces	Code	Barcode	Pk Qty
3,000	SLT-3000B	9314942123002	1
5,000	SLT-5000B	9314942157502	1

1.5mm Deep T Type Tile Spaces

- Deep T type spacer, for 1.5mm gaps
- For brick pattern tile laying where the T-Shape allows tiles to overlap
- For laying of thick tiles

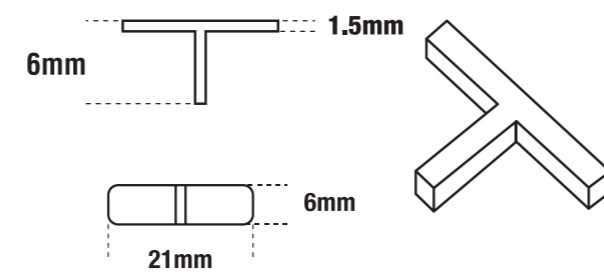

BAGS			
Pieces	Code	Barcode	Pk Qty
100	DST15-100	9314942688600	25
250	DST15-250	9314942688617	25
500	DST15-500	9314942688624	50

Tile Wedges

- Wedge type spacer, allows 0.5 - 5mm gap under wall tiles
- To level wall tiles if the floor is uneven or needs slight adjustment
- Rough surface for extra grip

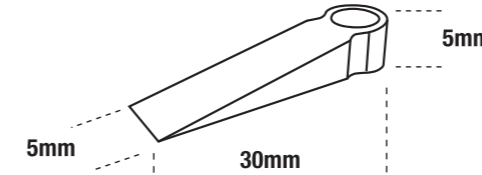

BAGS			
Pieces	Code	Barcode	Pk Qty
100	W-100	9314942601005	100
500	W-500	9314942605003	30
1,000	W-1000	9314942610007	12

BUCKETS

Pieces	Code	Barcode	Pk Qty
2,000	W-2000B	9314942602002	6
10,000	W-10000B	9314942658023	1

Jumbo Wedges

- Wedge type spacer 0.5 - 6.6mm
- To level large tiles on an uneven surface or where tiles need a slight adjustment
- Rough surface for extra grip

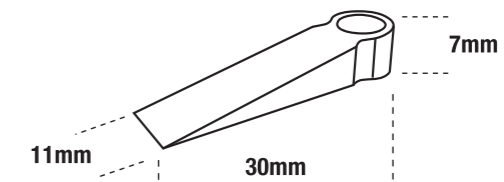

Pieces	Code	Barcode	Pk Qty
250	WJ-250	9314942657729	30
500	WJ-500	9314942657736	30

Lippage Caps

- Caps secure to lippage spacer
- Designed to level lippage on tiles when laying
- Caps are reusable
- Ideal for floors and walls

DIMENSIONS - 40mm(L) x 11mm(W) x 15mm(H)



BAGS

Pieces	Code	Barcode	Pk Qty
100	LIPC100	9314942664321	15

BUCKETS

Pieces	Code	Barcode	Pk Qty
250	LIPC250B	9314942666233	6

Universal Lippage Spacer

- Can be used with other lippage systems on the market
- Made of nylon
- Curved base to allow for different tile thicknesses
- Suitable for up to 60mm high

DIMENSIONS - 108mm(L) x 11mm(W) x 1.5mm(T)



BAGS

Pieces	Code	Barcode	Pk Qty
100	LIPSU100	9314942668411	15

BUCKETS

Pieces	Code	Barcode	Pk Qty
250	LIPSU250B	9314942668428	10

CARTONS

Pieces	Code	Barcode	Pk Qty
1,000	LIPSU1000C	9314942668442	1
2,000	LIPSU2000C	9314942668459	1

Lippage Spacers

- Used in conjunction with lippage caps
- Made from nylon
- Designed to level lippage on tiles when laying
- Ideal for floors and walls
- Curved base to allow for different tile thicknesses
- Suitable for up to 30mm high

DIMENSIONS - 75mm(H) x 14mm(W) x 1.9mm(T)



BAGS

Pieces	Code	Barcode	Pk Qty
100	LIPS100	9314942664344	1

BUCKETS

Pieces	Code	Barcode	Pk Qty
250	LIPS250B	9314942664338	10
500	LIPS500B	9314942666219	2
1,000	LIPS1000B	9314942666226	1

Lippage Starter Kit

Code: LIPK100

Barcode: 9314942666516

Pk Qty: 6



- Includes:
 - Lippage levelling gun
 - 100 lippage caps
 - 100 lippage spacers



Lippage Levelling Gun

Code: LIPTL

Barcode: 9314942666134

Pk Qty: 24



- To be used with lippage system
- Ensures correct tension on spacer and cap
- Light weight durable construction
- Foam handle



Trade Lippage Levelling Gun

Code: LIPTLT

Barcode: 9314942669074

Pk Qty: 10



- 4 levels of tension and breaking point to ensure correct tension on cap and spacer
- Light weight durable construction



Tile Lippage Levelling Kit

Code: LIPTTK

Barcode: 9314942669609

Pk Qty: 1



- Holds tiles level
- Ideal for walls and floors
- Eliminates lippage on uneven tiles
- Trade trolley with wheels and extendable handle x 1pc
- 400 x Lippage Caps
- 1000 x Standard Lippage Spacers
- 2 x Trade Lippage Guns



Livello Levelling System

Code: LLS150

Barcode: 9314942693833

Pk Qty: 1



- 150pcs per bucket
- Fully reusable levelling system
- Max tile thickness 16mm / 5/8"
- No remnants left in the tile adhesive
- No additional tools required for installation



Wedge - Wedge Levelling System

- Holds tiles level
- Ideal for walls and floors
- Eliminates lippage on uneven tiles



Pieces	Code	Barcode	Pk Qty
100	WLW100	9314942675655	10
250	WLW250	9314942680208	4



Stone Spacer - Wedge Levelling System

Code: **WLS250ST**
 Barcode: **9314942681106**
 Pk Qty: **20**



- 250 pieces
- Holds stone level
- Eliminates lippage on uneven stone
- Designed for use with stone



Spacer - Wedge Levelling System

- Holds tiles level
- Ideal for walls and floors
- Eliminates lippage on uneven tiles



Pieces	Code	Barcode	Pk Qty
250	WLS250	9314942676416	20
500	WLS500	9314942680147	12
2,000	WLS2000	9314942681090	1



Wedge Levelling Tool

Code: **WLFT**
 Barcode: **9314942678465**
 Pk Qty: **24**



- Adjustable tension
- Adjustable for different tile thicknesses
- Tile levelling system for quick tile installation and lippage-free surface
- Comes with both single and double prong adaptors



Wedge Levelling Trolley Kit

Code: **WLTK**
 Barcode: **9314942681632**
 Pk Qty: **1**



- Holds tiles level
- Ideal for walls and floors
- Eliminates lippage on uneven tiles
- Trade trolley with wheels and extendable handle
- 600 x Wedges
- 1200 x Spacers
- 1 x Levelling Tool



Spacer - Flatout Levelling System

- Use for tile thickness 2-12mm
- Holds tile level
- Ideal for walls & floors
- Eliminates lippage on tiles



Pieces	Size	Code	Barcode	Pk Qty
250	1mm	FLS1-250	9314942692263	12
500	1mm	FLS1-500	9314942692270	6
250	1.5mm	FLS15-250	9314942691372	12
500	1.5mm	FLS15-500	9314942691389	6
250	2mm	FLS2-250	9314942691396	12
500	2mm	FLS2-500	9314942691402	6
250	3mm	FLS3-250	9314942691501	12



Stone Spacer - Flatout Levelling System

- Use for tile thickness 2-12mm
- Holds tile level
- Ideal for walls and floors
- Eliminates lippage on tiles



Pieces	Size	Code	Barcode	Pk Qty
100	2mm	FLTS2-100	9314942689997	27
250	2mm	FLTS2-250	9314942693420	10



Wedge - Flatout Levelling System

- Holds tile level
- Ideal for walls and floors
- Eliminates lippage on tiles
- For use with different size clips
- Size: 98(L)x22(W)x20(H)mm



Pieces	Code	Barcode	Pk Qty
100	FLW-100	9314942690009	12
250	FLW-250	9314942691419	5



Flatout levelling Kit

Code: **FLS KIT**
 Barcode: **9314942694823**
 Pk Qty: **1**



- Holds tile level
- Ideal for walls & floors
- Eliminates lippage on tiles
- 300 x Wedges
- 1500 x 1.5mm Spacers
- 1 x Levelling Tool



Adhesive Mosaic Mesh 300 x 300mm

DIY

- Designed to fix behind mosaic tiles to increase the thickness so they sit level with other tiles
- Supports mosaics and prevents slipping
- Makes mosaic tiling quick and easy
- Size - 300mm x 300mm x 1mm

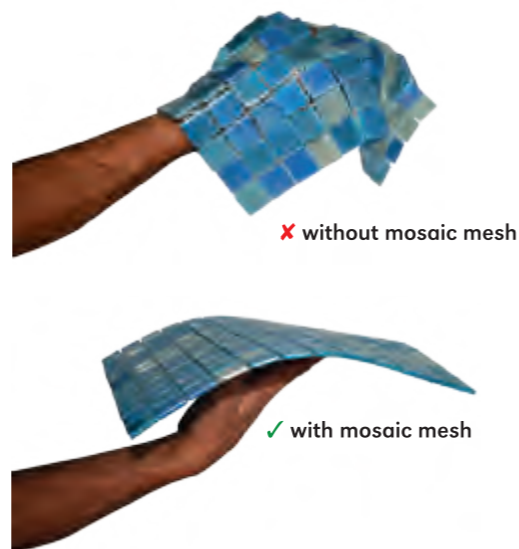
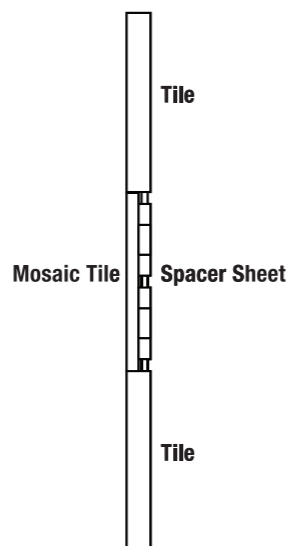
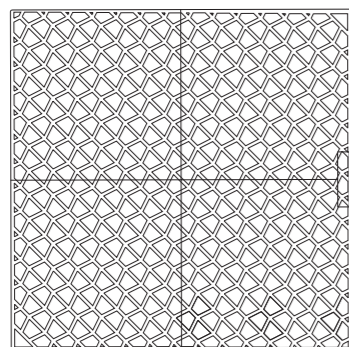

Pieces	Code	Barcode	Pk Qty
5	TMS5A	9314942671886	10
50	TMS50A	9314942671893	10

Mosaic Spacer Sheet 300 x 150mm

DIY

Code: TMS10

Barcode: 9314942667759

Pk Qty: 10

- Designed to fix behind the mosaic sheets to increase the thickness of the tiles
 - 10 sheets per pack
 - The sheet is easily cut for different designs
- SIZE - 300mm x 150mm x 2.5mm

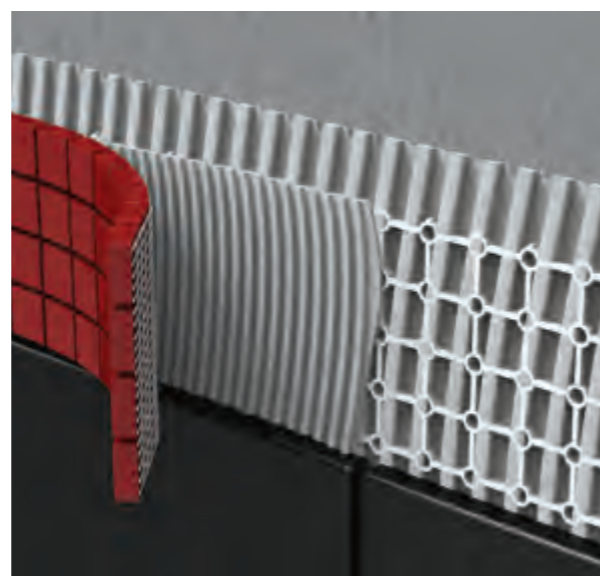
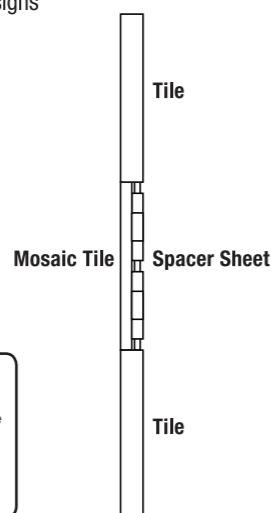

VIDEO DEMO
 1.To view the video, download any QR Code Reader App. on your smart phone.
 2.Scan the QR Code to watch video.



GROUTING & CLEAN-UP

DTA knows that grout is the finishing touch that says “professionalism”, but grouting is messy. DTA covers both areas, with tools that give your grout a smooth, even finish plus a range of clean-up systems that quickly and easily remove excess grout, getting you the seal of approval from your customers.



BOSS 1400 Watt Electric Mixer

Code: **M1400**

Barcode: **9314942680024**

Pk Qty: **1**



- 1400 watt motor
- Variable speed switch
- Soft grip handle
- Includes spiral mixing paddle 140mm, MH3140
- Soft start
- AS/NZS 60745.1:2009 Approval



BOSS 1600 Watt Electric Mixer

Code: **M1600MK2**

Barcode: **9314942692799**

Pk Qty: **1**



- 1600 watt motor
- Variable speed switch
- Soft grip handle
- Includes spiral mixing paddle
- Soft start
- AS/NZS 60745.1:2009 Approval



Economy Glue Mixer Small

Code: **AGL**

Barcode: **9314942701033**

Pk Qty: **12**



- 80mm DIAMETER with 8mm DIAMETER SHAFT**
- Powdercoated steel construction
 - Use with an electric drill for fast and efficient mixing
- DIMENSIONS 80mm(D) x 8mm(S) x 400mm(L)



Mixers - Nickel Plated

- Nickel plated steel construction
- Used for grout and/or adhesive mixing



Size	Code	Barcode	Pk Qty
90mm(D) x 8mm(S) x 600m(L)	DTAWM90	9314942655794	6



BOSS Twist Mixer

Code: **MH2140**

Barcode: **9314942140016**

Pk Qty: **1**



- 140mm Twist Mixing Paddle
- Works material upwards
- Suitable for M1400 and M1600MK2



Steel Glue Mixer

Code: **SSGM**

Barcode: **9314942890898**

Pk Qty: **6**



- 128mm DIAMETER with 10mm DIAMETER SHAFT**
- Chrome-plated steel construction
 - Use with an electric drill for fast and efficient mixing
- DIMENSIONS - 128mm(D) x 10mm(S) x 560mm(L)



Glue / Paint Mixer

- Available in small, medium or large
- Nickel plated steel construction
- Use with an electric drill for fast and efficient mixing



	Code	Barcode	Pk Qty
80mm(D) x 8mm(S) x 450mm(L)	GPMS	9314942000808	6
100mm(D) x 10mm(S) x 440mm(L)	GPMM	9314942010104	6
130mm(D) x 10mm(S) x 520mm(L)	GPML	9314942001300	6



BOSS Spiral Mixer

Code: **MH3140**

Barcode: **9314942140023**

Pk Qty: **1**



- 140mm Spiral Mixing Paddle
- Works material both upwards and downwards
- Suitable for M1400 and M1600MK2





Handyman Grouter

- Comfortable plastic handle with durable rubber grouting strip
- Easy to manoeuvre and ideal for small renovations



Size	Code	Barcode	Pk Qty
150mm	HG6	9314942450061	24
230mm	HG9	9314942450092	24



Plastic Rubber Pointed Trowel

Code: PRPT

Barcode: 9314942240242

Pk Qty: 12



- Durable, lightweight plastic with rubber base
- Ideal for small or large renovations



Japanese Rubber Pointed Trowel

Code: RPT

Barcode: 9314942242406

Pk Qty: 4



- Highest quality rubber base with wooden handle
- Pointed front for grouting internal wall or floor corners



Trade Hand Grouter

- Larger handle and rubber grouting strip for optimal comfort and durability
- Ideal for grouting larger tiled areas



Size	Code	Barcode	Pk Qty
150mm	TG6	9314942460060	24
230mm	TG9	9314942460091	24



Handyperson Rubber Pointed Trowel

Code: HRPT

Barcode: 9314942243007

Pk Qty: 6



- Lightweight and durable rubber base with comfortable handle
- Pointed front for grouting internal wall or floor corners



Rubber Float

- Rectangular rubber float
- Made of a foam core construction with a rubber base



Size	Code	Barcode	Pk Qty
100mmx230mm	DTARF9	9314942242437	12
100mmx300mm	DTARF12	9314942242413	12



Bucket Dust Extractor

Code: DEXBA

Barcode: 9314942690214

Pk Qty: 20



- Dust-free mixing
- Includes rubber adaptor
- Used in conjunction with industrial vacuums
- Suitable for most buckets
- Ideal when mixing powder adhesives, grouts and plaster



DTA 20L Bucket

Code: DTAB20

Barcode: 9314942667773

Pk Qty: 5



- 20L measuring bucket
- Measurements in litres, gallons and quart
- Lid included



Grout Cleaning Kit

Code: DTAGCK

Barcode: 9314942659877

Pk Qty: 6



- Includes Grout Brush, Handle and 200ml Grout Cleaner
- Grout Brush has a V shape to clean grout lines
- Grout Brush has a soft rubber handle
- Grout Cleaner is a heavy-duty formula
- Effectively cleans and deodorises tiles and grout
- Useful all-purpose cleaner and brush



Grout Scrubber with Extendable Metal Handle

Code: DTAGS

Barcode: 9314942655121

Pk Qty: 12



- Effective brush for cleaning grout
- Telescopic steel handle
- Use for tiled walls and floors
- Polymer cleaning head



Grout Scrubber

- V shape to clean grout lines
- Soft rubber handle
- For best results use Scrubber in conjunction with DTA Heavy Duty Grout Cleaner
- Use for tiled walls and floors



Product	Code	Barcode	Pk Qty
Grout Scrubber	DTAGSB	9314942655381	12
Long Grout Brush Handle Steel	DTAGSH	9314942660170	1
Short Grout Brush Handle	DTAGSHS	9314942659884	1



Articulated Sponge Handle

Code: **CLSPA**
 Barcode: **9314942663737**
 Pk Qty: **10**



- Articulated for easy cleaning
- Ideal for grout clean-up and general purpose cleaning



Universal Aluminium Long Handle

Code: **DTAUH**
 Barcode: **9314942666578**
 Pk Qty: **10**



- Long aluminium handle
- 1500mm (L)
- Non-adjustable
- For use with CLSPA



BOSS GT Series Grout Clean Up System

Code: **BGCS18**
 Barcode: **9314942690993**
 Pk Qty: **1**



- 18L Trade Plastic Bucket
- Tri-Roller removes grout sediment and excess water
- Small Sponge 280 x 140mm
- Large Sponge 340 x 180mm
- Contoured Handle
- Sloping base and plastic grid to clear sediment
- Spare Grate: BGCS18 GRATE
- Spare Rollers: BGCS18R
- Spare Wheels: BGCS18W



Velcro Sponge Foam and Handle for Grout Clean-Up System

- Segmented design allows for efficient rinsing and grout removal



SPONGE DIMENSIONS - 280mm(L) x 140mm(W) x 30mm(D)

Product	Code	Barcode	Pk Qty
Velcro Handle	DTAVH	9314942256106	1
Velcro Hydro Sponge	DTAVSPD	9314942629778	1
Velcro Hydro Sponge and Handle	VDSH	9314942660514	1



Clip on Sponge and Handle

- Hydro sponge for extra absorption
- 4 Clips for extra strength
- Reusable handle



CLSPS DIMENSIONS - 280mm(L) x 140mm(W) x 30mm(D)

CLSP DIMENSIONS - 340mm(L) x 185mm(W) x 40mm(D)

Product	Code	Barcode	Pk Qty
Click on Handle	CLSPH	9314942661191	10
Click on Hydro Sponge	CLSP	9314942661184	10
Clip on Sponge Small	CLSPS	9314942661689	10



Polyurethane Floats

- Lightweight and easy to use
- Strong one piece handle and base
- Durable polypropylene construction
- Textured surface for use with concrete and renders



Product	Code	Barcode	Pk Qty
Polyfloat Small	DTAPFS	9314942675129	10
Poly Float Large	DTAPFL	9314942675136	10
Poly Float Extra Large	DTAPFXL	9314942679165	10



Blue All-Purpose Sponge

Code: **APS64B**
 Barcode: **9314942000648**
 Pk Qty: **20**



- Ideal for cleaning tiles after grouting
- DIMENSIONS - 160mm(L) x 120mm(W) x 37mm(D)



Yellow Tilers' and Slaters' Sponge

- Ideal for cleaning large tiled and slate areas after grouting
- Hydro sponge



Size	Code	Barcode	Pk Qty
300mm(L) x 200mm(W) x 50mm(D)	TSS128	9314942128007	16
215mm(L) x 150mm(W)x40mm(D)	TSS68	9314942664307	32
215mm(L) x 150mm(W)x40mm(D)	TSS68-6	9314942666264	6
190mm(L) x 130mm(W) x 55mm(D)	DTAXLPS	9314942668954	30



White Foam Sponge

- Ideal for cleaning tiles after grouting
- All purpose sponge



Size	Code	Barcode	Pk Qty
200mm(L) x 100mm(W) x 75mm(D)	LFS84	9314942000846	20
250mm(L) x 150mm(W) x 50mm(D)	LFS106	9314942001065	20



Foam Sponge - Large

- Ideal for cleaning large tiled areas after grouting



Size	Code	Barcode	Pk Qty
190mm(L) x 130mm(W) x 50mm(D)	SH4-200	9314942042006	30
160mm(L) x 110mm(W) x 50mm(D)	DTALPS	9314942042037	44





Scrubbing Sponge

Code: **DTASS**

Barcode: **9314942042020**

Pk Qty: **40**



- Ideal for cleaning large tiled areas after grouting
 - Hydro sponge
 - Ideal for epoxy grout
- DIMENSIONS - 160mm(L) x 120mm(W) x 45mm(D)



Grout Haze Sponge

Code: **SP-5722**

Barcode: **9314942000655**

Pk Qty: **20**



- Ideal for cleaning large tiled areas after grouting
 - Ideal for epoxy grout
- DIMENSIONS - 130mm(L) x 85mm(W) x 40mm(D)



Hydro Contractors Sponge

Code: **TCHS128**

Barcode: **9314942684916**

Pk Qty: **20**



- Multi-purpose hydro sponge
- Ideal for cleaning of grout
- 300mm(L) x 200mm(W) x 40mm(D)



Turtle Back Sponge

Code: **DTATBS**

Barcode: **9314942042013**

Pk Qty: **36**



- Ideal for cleaning large tiled areas after grouting
- DIMENSIONS - 180mm(L) x 115mm(W) x 70mm(D)



Micro Fibre Sponge

Code: **MFS75**

Barcode: **9314942666240**

Pk Qty: **32**



- Hydro sponge for high absorption
 - Microfibre is ideal for removing grout haze after drying
- DIMENSIONS: 200mm(L) x 150mm(W) x 50mm(D)



Scouring Pad with Handle

- Ideal for removing grout haze and wax from tiles

• Scouring set includes:

- Fine Pad - Designed for surfaces that are sensitive to scratching
- Medium Pad - Ideal for removing grout residue from newly laid tiles
- Coarse Pad - Ideal for removing old waxes and sealers from tiles



Product	Code	Barcode	Pk Qty
Scouring Pad with handle - Triple pack	SCTP	9314942659709	15
Scouring Pad Fine	SCTPF	9314942660415	15
Scouring Pad Medium	SCTPM	9314942660408	15
Scouring Pad Coarse	SCTPC	9314942660392	15



Economy Grout Remover

Code: **DTAGRE**

Barcode: **9314942229148**

Pk Qty: **6**



- Durable steel tooth blade (non-interchangeable)
- Ideal for small repair jobs



Combination Tile Scriber / Grout Remover

- Multi-function tile glass cutter and grout remover tool
- Small tungsten carbide scoring wheel and two steel pins for tile and glass breaking
- Grout remover comes with two tungsten carbide tipped blades
- Safe storage for second blade within PVC handle



Product	Code	Barcode	Pk Qty
Tile Scriber/Grout Remover	22-291CG	9314942515258	6
Replacement Blades	22-291ESB	9314942192213	6



Tile Grout Remover - Economy

- Twin blade design enables grout removal from wide or tight joints

• Corrosion-resistant bright metal finish

• Includes tungsten carbide tipped and steel toothed blade

- Angled handle for applying heavy pressure allows faster and safer cutting



Product	Code	Barcode	Pk Qty
Tile Grout Remover - Economy	22-291E	9314942192220	6
Replacement Blades	22-291ESB	9314942192213	6



Diamond Grout Remover - Deluxe

- Twin blade design enables grout removal from wide or tight joints

• Corrosion-resistant oxidised metal finish

- Angled handle for applying heavy pressure allows faster and safer cutting



Product	Code	Barcode	Pk Qty
Tile Grout Remover	22-291	9314942222910	6
Replacement Blades	22-291DB	9314942222927	6



CLEANERS & PROTECTORS

DTA manufactures an effective range of tile cleaners, sealers and anti-slip. The range of cleaners are ideal for initial cleaning of tiles as well as an all purpose cleaner.

Anti-Slip

- Fluoride based formula controls slipping on ceramic, mosaic and quarry tiles, terrazzo and unpainted concrete floors
- Alters surface texture yet maintains the appearance of the floor



Size	Code	Barcode	Pk Qty
1ltr*	AS1L	9314942101000	10
5ltr*	AS5L	9314942102007	4

*Coverage: 10sqm per litre



VIDEO DEMO
 1.To view the video, download any QR Code Reader App. on your smart phone.
 2.Scan the QR Code to watch video.



Grout Sealer

- Protects grout from staining
- Non-hazardous
- Effectively waterproofs grout



Size	Code	Barcode	Pk Qty
250ml (10mt)*	PL250S	9314942002505	12
500ml (20mt)*	PL500S	9314942005001	6
1ltr (40mt)*	PL1LTRS	9314942010005	6

*Coverage: dependent on width of grout joint



Grout Cleaner

- Heavy-duty formula
- Effectively cleans and deodorises tiles and grout
- Useful all-purpose cleaner



Size	Code	Barcode	Pk Qty
200ml	GC200	9314942102502	12
750ml (CitrusScent)	GC750C	9314942661580	8



Grout Sealer Applicator

Code: **GSAW**
 Barcode: **9314942674689**
 Pk Qty: **10**



- Faster and easier than a brush
- For use with silicone, latex and acrylic based sealer and stains
- Includes two wheels 3mm and 5.5mm widths



Enduro Shield DIY Kit Glass



- A permanent protective coating for shower screens and all glass surfaces
- Simple to apply
- Invisible coating that repels water, soap scum and grime
- This is a ONCE ONLY application

Code	Size	Pk Qty
ESG	125ml	10



Enduro Shield DIY Kit Tile & Grout



- A permanent protective coating for ceramic tiles and grout
- Simple to apply
- Invisible coating that repels water, soap scum and grime
- This is a ONCE ONLY application

Code	Size	Pk Qty
EST	125ml	10
EST500	500ml	10



Silicone Applicators



- Quickly removes excess silicone
- Forms a neat cove or fillet without masking tape

Size	Code	Barcode	Pk Qty
Small	DTASA	9314942217909	2



Paint Roler Kit

Code: **PRWPK**
 Barcode: **9314942693154**
 Pk Qty: **16**



- 10mm nap roller
- Plastic tray
- 100mm brush
- Ideal for waterproofing membrane
- Replacement rollers code:PRWRC



Grout Applicator



- Suitable for normal grout and epoxy grout
- Minimises waste and clean up
- Body cartridge is reusable and can easily be replaced with any 50mm PVC pipe

Product	Code	Barcode	Pk Qty
Grout Applicator	DTAGG	9314942678830	10
Spare Nozzie for DTA grout Gun	DTAGGN	9314942680055	10



Sausage Caulking Gun



- No loss trigger to reduce run on
- Pressure release trigger
- Compatible for use with most sausage packs up to 600ml in volume
- Maximum use of sealant with minimum waste
- Replacement nozzles available

Product	Code	Barcode	Pk Qty
Sausage Caulking Gun	TCG15	9314942656883	6
Spare Nozzie	TCG15SN	9314942653238	10



Trade Caulking Gun



Code: **DTATCG**
 Barcode: **9314942072904**
 Pk Qty: **6**

- Holds 310ml tubes
- Heavy-duty steel construction with comfortable contoured handle





Felt Protective Roll

Code: **DSFR**
 Barcode: **9314942669647**
 Pk Qty: **6**



- 1 metre x 10 metre
- Anti-Absorbent Backing
- Made from recycled fabric
- Ideal for tiling, painting and renovating



Floor Protector Roller Applicator

Code: **FPA700**
 Barcode: **9314942678441**
 Pk Qty: **6**



- Stainless steel barrel
- Push action
- For easy application of film
- For use with carpet protection film
- 700mm



Heavy Duty Floor Protection Applicator

Code: **FPAHD**
 Barcode: **9314942681724**
 Pk Qty: **6**



- Stainless steel barrel
- Push action for easy application of film
- For commercial and domestic use
- For use with carpet protection film
- Suitable for 700mm and 1000mm film rolls



Plastic Zip Door



- Helps prevent mess spreading whilst renovating
- Heavy duty clear plastic material
- Allows access into work areas that have been sealed off to contain dust and debris
- Suitable for doorways up to 1 metre wide
- Commercial grade polyester zipper



DIMENSIONS: 2.2m(H) x 1.1m(W)

Product	Code	Barcode	Pk Qty
Plastic Zip Door with Masking Tape	DPZT	9314942667476	10
Plastic Zip Door without Masking Tape	DPZ	9314942667643	10

Dust Shield Temporary Wall System Kit



Code: **DSKD**
 Barcode: **9314942674115**
 Pk Qty: **6**

VIDEO DEMO

1. To view the video, download any QR Code Reader App. on your smart phone.
 2. Scan the QR Code to watch video.

- 4 x Aluminium extension poles extends to 3.9m
- 4 x Base plates 4 x Top plates
- 1 x Clear film 4m x 5m x 60um
- 2 x Adhesive zips 2m
- 12 x Pole U-Clips
- 1 x 1400mm Aluminium support bar
- 1 x Carry bag



Aluminium Support Bar



Code: **DSSB1400**
 Barcode: **9314942674139**
 Pk Qty: **6**

- Support bar attaches to the extension pole
- 1400mm with Foam Padding



Aluminium Extension Pole



Code: **DSEP**
 Barcode: **9314942674122**
 Pk Qty: **6**

- Extends to 3.9m
- Secures plastic film to top plate and extend to ceiling



Extension Pole U-Clips 12 Pieces



Code: **DSC12**
 Barcode: **9314942674146**
 Pk Qty: **6**

- Secures plastic film to extension poles



Adhesive Access Zip



Code: **DSZIP**
 Barcode: **9314942674177**
 Pk Qty: **6**

- Adhere adhesive zip at desired access point
- Open zip and slice plastic to allow access
- 215cm Long



Clear Plastic Film



Code: **DSPFC**
 Barcode: **9314942674153**
 Pk Qty: **6**

- Heavy duty HDPE plastic material
- Allows access into work areas that have been sealed off to contain dust and debris
- 4m x 5m x 60um



The Choice of Professionals

After 35 years of successfully servicing the tiling tools and accessories segment, DTA is now taking the brand into the wider flooring tools and accessories market. DTA has developed a complete range of professional and DIY carpet, laminate and vinyl floor trims and accessories. Through consultation with the trade in Australia and internationally DTA are able to offer a range of innovative trims in suitable materials, that satisfy the most demanding customer applications. DTA trims are available from retail outlets, or supplied from the state warehouses.

Corner Roller 25mm Brass

Code: **FFCR**

Barcode: **9314942663447**

Pk Qty: **12**

DIY
TRADE

- Ideal for rolling vinyl joints
- Solid 25mm brass wheel
- Light weight handle



Vinyl Trimmer Guide

Code: **FVTG**

Barcode: **9314942664567**

Pk Qty: **15**

DIY
TRADE

- Designed to use with the Vinyl Trimming Knives (FASC and FLK) as an easy flow guide for the perfect weld cut every time



Axe Shaped Cutter

Code: **FASC**

Barcode: **9314942663652**

Pk Qty: **10**

DIY
TRADE

- Cuts both linoleum and vinyl
- Made with heavy gauge steel
- Assists with accurate even cuts
- Soft grip handle



Vinyl Trimming Knife

Code: **FLK**

Barcode: **9314942663669**

Pk Qty: **10**

DIY
TRADE

- Cuts both linoleum and vinyl
- Made with a heavy gauge steel
- Double edge sharp blade provides years of perfect cuts
- Soft grip handle



Resilient Rollers

- Designed for rolling vinyl joints
- Highly polished chromed brass rollers are 2" x 2" (50mm x 50mm)
- Three edges available:
 - Outside Round Edge - Left Handed
 - Inside Round Edge - Right Handed
 - Square Edge - Universal

DIY
TRADE

Type	Code	Barcode	Pk Qty
Outside Round Edge	FRRO	9314942663515	12
Inside Round Edge	FRRI	9314942663522	12
Square Edge	FRRSQ	9314942663539	12



Timber and Laminate Repair Kit

Code: **FLRK**

Barcode: **9314942681359**

Pk Qty: **12**

DIY

- Ideal for repairing scratches and marks on timber and laminate floors
- Battery operated melting device (Batteries included)
- 11 wax colour sticks
- Blend wax colour sticks to create more colours



Timber Laminate Laying Kit Small

Code: **FLLKS**
 Barcode: **9314942669623**
 Pk Qty: **10**



- Ideal for use when laying timber laminate floors
- Kit Includes - tapping block, pull bar and 20 wedges



Timber Laminate Laying Kit Large

Code: **FLLKL**
 Barcode: **9314942663713**
 Pk Qty: **12**



- Ideal for use when laying timber laminate floors
- Kit includes - tapping block, pull bar and 40 wedges



Timber Laminate Wedges

Code: **FLLW20**
 Barcode: **9314942664857**
 Pk Qty: **12**



- 20 pieces per packet
- Wedge design for easier adjustment



Floor Wedge

Code: **WFW-4**
 Barcode: **9314942686583**
 Pk Qty: **12**



- Insert between the wall and the first row of flooring
- Adjustable to work with uneven walls
- Durable construction
- Adjustable dial setting (5mm-20mm / 3/16"-3/4")
- 60mm / 2-3/8" face width



180mm DuckBill Nap Shears

Code: **CDNS180**
 Barcode: **9314942664963**
 Pk Qty: **12**



- Ideal for trimming any loose carpet threads
- Duckbill designed blades for easier trimming
- Easy grip handle



200mm Carpet Nap Shears

Code: **CNP8**
 Barcode: **9314942664970**
 Pk Qty: **12**



- Ideal for trimming any loose carpet threads
- Easy grip handle



Trimming Knife with Blade

Code: **CTK**
 Barcode: **9314942662730**
 Pk Qty: **12**



- Ideal for cutting in corners
- Safety guards to keep blades in place
- Light weight design
- Blades easily changed
- Handle stores extra blades with magnetic clip

REPLACEMENT BLADES - **CTB10**



Trimming Blade

Code: **CTKB10**
 Barcode: **9314942664772**
 Pk Qty: **100**



- Pack of 10 spare blades
- Designed to suit CLPC - Loop Pile Cutter and DTARK - Utility Knife

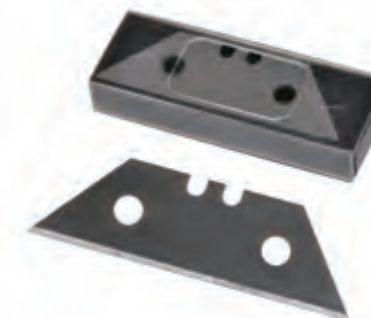

Trimming Blade

Code: **CTB10**
 Barcode: **9314942664789**
 Pk Qty: **100**



- Pack of 10 spare blades
- Designed to suit CTK - Trimming Knife and CCBC - Cushion Back Trimmer and CLPC - Loop Pile Cutter



Trimming Blade Hook Type

Code: **CTBH10**
 Barcode: **9314942664918**
 Pk Qty: **100**



- Pack of 10 spare hook blades
- Designed to suit CDWT - DIY Carpet Wall Trimmer



Professional Adjustable Carpet Knee Kicker

Code: **FAKK**
 Barcode: **9314942663584**
 Pk Qty: **9**



- Designed to stretch and attach carpet to the carpet gripper
- 5 Pin adjustable length setting
- Lever action length adjustment
- Knee shock reducing bumper pad
- Pin dial gives visual reference



DIY Knee Kicker

Code: **FDKK**
 Barcode: **9314942663577**
 Pk Qty: **12**



- Designed to stretch and attach carpet to the carpet gripper
- Light weight
- Knee bumper pad
- Compact design



90mm Stair Tool

Code: **FST90P**

Barcode: **9314942663591**

Pk Qty: **12**



- The heavy duty blade easily sets carpet into stairs
- Ideal for tucking carpet along skirting boards
- Cushion grip rubber handle



Seam Squeezer

Code: **FSS**

Barcode: **9314942663614**

Pk Qty: **10**



- Powerful squeezing spring forces carpet together
- Produces an improved seam



Carpet Seam Roller - 11 teeth

Code: **FCSR9011**

Barcode: **9314942663485**

Pk Qty: **14**



- Ideal for seaming loop and berber style carpets
- Star wheel blends carpet yarn at the seams
- Soft grip handle
- Size: 3.5" (90mm)



Carpet Seam Roller - 19 teeth

Code: **FCSR15019**

Barcode: **9314942663461**

Pk Qty: **14**



- Ideal for seaming loop and berber style carpets
- Star wheel blends carpet yarn at the seams
- Soft grip handle
- Size: 6" (150mm)



DIY Carpet Wall Trimmer

Code: **CDWT**

Barcode: **9314942664932**

Pk Qty: **6**



- Easy to use just press the cutter down and pull it along to trim excess carpet along the wall
- Hook blades included

REPLACEMENT BLADES - **CTBH10**



Cushion Back Trimmer

Code: **CCBC**

Barcode: **9314942661726**

Pk Qty: **12**



- Designed for cutting loop pile carpet
- Comfort grip handle
- Blades included

REPLACEMENT BLADES - **CTB10**



Carpet Heat Seam Tape

- The knitted backing pad will not stick to the underlay
- It has fibreglass reinforcement giving it a stronger bonding
- Available in 20 metre rolls in three widths 88mm, 105mm and 150mm



Code	Barcode	Size	Pk Qty
CHST20.88	9314942665106	88mm x 20m	1



Code	Barcode	Size	Pk Qty
CHST20.105	9314942665120	105mm x 20m	1
CHST20.150	9314942665144	150mm x 20m	1

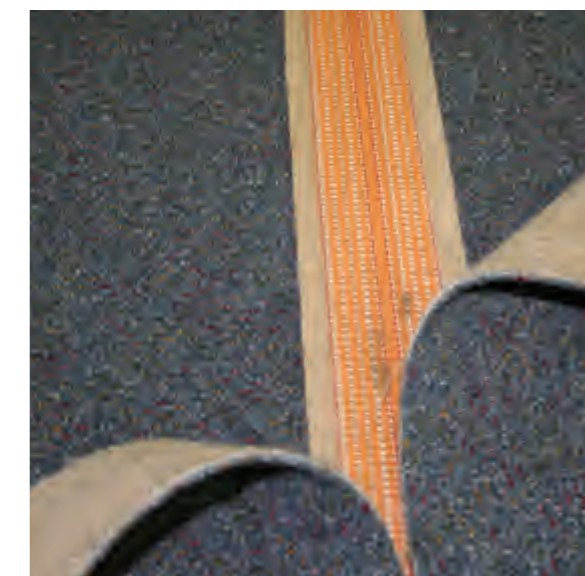

Loop Pile Cutter

Code: **CLPC**

Barcode: **9314942661733**

Pk Qty: **10**



- Long nose for better pile separation
- Strong base design
- Push action for easy cutting
- Blades easily changed

REPLACEMENT BLADES - **CTKB10 and CTB10**



Carpet Seam Roller Smooth 5"

Code: **FCSR125**

Barcode: **9314942663492**

Pk Qty: **14**



- Smooth roller designed for safe seaming of cut pile carpets
- Rugged steel frame
- Special design handle for optimum leverage
- Size: 5" (125mm)



Nails for Gripper Strip

- Ideal for carpet gripper
- DTA Heavy Duty Concrete Nails are available in 16mm x 500g or 1kg
- DTA Dual Purpose Timber Nails are available in 18mm x 500g and 1kg

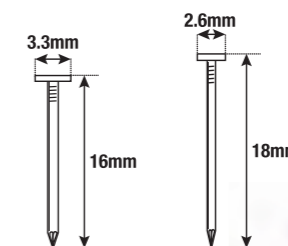

Heavy Duty Concrete Nails		3.3mm WIDE	16mm LONG
Code	Barcode	Size	Pk Qty
CGNC500.16	9314942665052	500g	5
CGNC1.16	9314942665069	1kg	5

Dual Purpose Timber & Concrete Nails		2.6mm WIDE	18mm LONG
Code	Barcode	Size	Pk Qty
CGNDP500.18	9314942665076	500g	5
CGNDP1.18	9314942665083	1kg	5



MERCHANDISING

To help you sell DTA, the strongest brand in the tiling tools and accessories market, we have a range of merchandising materials and modular stands. These help increase customer purchases and brand awareness. Call our customer service representatives to help you choose the products that will increase your DTA sales.

Tool Merchandising Stand

DIMENSIONS - 1m(W) x 2m(H)



- Neatly and conveniently displays tools in stores
- Can be individually tailored to suit store requirements

Product	Code	Pk Qty
Tool Stand	DTATD	1
Basket for Tools	DTATDB	1
Shelf for Stand	DTATDS	1
150mm Peg Board Hook with Flipper Tag	PBH150	1
250mm Peg Board Hook with Flipper Tag	PBH250	1
Trowel Rack 9 piece	DTATDTR	1



Trim Merchandising Stand

DIMENSIONS - 1m(W) x 2m(H)



- Neatly and efficiently displays PVC and metal trims in stores
- Can be individually tailored to suit store requirements

Product	Code	Pk Qty
Trim Stand	DTATD	1
Hanging Hooks for Trims	DTATDH	1
Trim Divider Brackets	DTATDHT	1



1 metre Tool and Trim Stand

DIMENSIONS - 1m(W) x 1.2m(H)



- Neatly and conveniently displays tile cutters in stores
- Can be individually tailored to suit store requirements

Product	Code	Pk Qty
1m Tool and Trim Stand	DTATD1M	1
Hanging Hooks for Trims	DTATDH	1
Basket for Tools	DTATDB	1
Trim Divider Brackets	DTATDHT	1
Shelf for 1m Stand	DTATDS	1
50mm Peg Board Hook with Flipper Tag	PBH150	1
250mm Peg Board Hook with Flipper Tag	PBH250	1
Trowel Rack 9 piece	DTATDTR	1

